

A bedroom scene featuring a large teal wardrobe with silver handles, a bed with white linens, a patterned rug, and a pendant lamp. The text 'THE Bedroom COLLECTION' is overlaid on the image.

THE
Bedroom
COLLECTION



THE
Bedroom
COLLECTION

Your bedroom is a sanctuary for relaxation and tranquillity in the home, that's why creating the perfect space matters.

A bedroom should seamlessly balance design and function, and with that in mind, our collections combine beautifully finished furniture with clever storage. Versatile, flexible and stylish, our furniture fits perfectly with modern lifestyles.

With the very latest in fitted furniture styles, let this brochure inspire you with new possibilities to design the bedroom of your dreams.







Contents

Classic Collection	2
Chapter	4
Origin	8
Modern Collection	14
Parity	16
Flow	20
Sculpt	24
Esker	28
Walk-in Collection	36
Made-to-Measure	54
Alpina	56
Stanhope	62
Unity	72
Sliding	80
Finishing Touches	90
Handles	92
Lighting	108
Chest Collection	114
Bed Collection	124
Planning and Guidance	127



Classic

COLLECTION

Inspired by the exquisiteness and craft of the past, followers of this classic style have an eye for timeless design. From the simple beauty of Origin to the refined decadence of Chapter, this collection's neutral colour palette allows you to create your own take on this traditional look.

Available in a Partridge Grey, Stone, Porcelain and Oak effect.



Chapter

CLASSIC COLLECTION



Doors: Chapter
Textured woodgrain effect: Partridge Grey
Handle: Hampshire knob from the Pewter collection (KDH3025)



Chapter

CLASSIC COLLECTION

A decadent twist on a classic Shaker, the simple profile, ornate beading and neutral colour palette all help to create an elegant bedroom interior.

Available in four finishes; three textured painted woodgrains and a textured oak.



Chapter in Partridge Grey with mirror



Spencer handle from the Timber Collection (KDH3021)



Additional shelves in Linen finish

Textured woodgrain effect

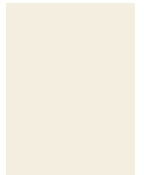

PORCELAIN

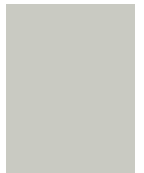

PARTRIDGE GREY

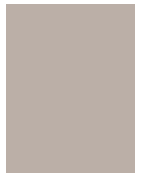

STONE



OAK



Origin

CLASSIC COLLECTION



Doors: Origin
Textured woodgrain effect: Stone
Handle: Leeming from the Nickel Collection (KDH3010)



Doors: Origin
Textured woodgrain effect: Partridge Grey
Handle: Bloomfield from the Black Collection (KDH3020)

Origin

CLASSIC COLLECTION

This crisp Shaker design, coupled with its woodgrain finish, allows the range to sit comfortably in both modern and period homes. The versatile choice when it comes to creating a bedroom that's unique to you.

Available in three textured painted woodgrains and a textured oak.



Origin doors in Stone



Spencer handle from the Timber Collection (KDH3021)



Two deep stackable drawers in Linen with additional Linen shelf

Textured woodgrain effect

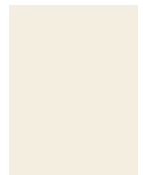

PORCELAIN

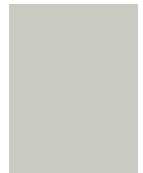

PARTRIDGE GREY



STONE



OAK

CLASSIC RANGE OVERVIEW

Chapter and Origin
Component and complete

TEXTURED WOODGRAIN EFFECT

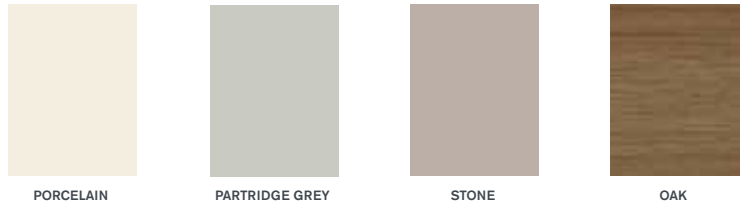

COMPONENT - DOORS

Door length:
2154mm
Door Depth:
19mm
Mid Rail Height:
741mm



SINGLE DOOR

397mm
447mm
497mm



MIRROR DOOR

497mm

Door Height:
447mm
Door Depth:
19mm



FEATURE DOOR

397mm
447mm
497mm

COMPLETE - WARDROBES

Wardrobe Height:
2260mm

Wardrobe Depth:
610mm

Mid Rail Height:
741mm

Door length:
2154mm



SINGLE WARDROBES LH / RH

400mm
450mm
500mm



DOUBLE WARDROBES

800mm
900mm
1000mm



CORNER ROBE LH/RH

1000mm
1150mm including void when fitted

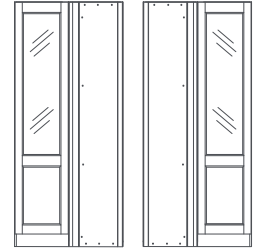

CORNER ROBE MIRROR LH/RH

1000mm
1150mm including void when fitted

MIRRORED WARDROBES



MIRROR LH/RH

500mm



DOUBLE MIRROR

1000mm

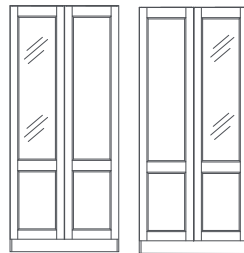

DOUBLE LH/RH MIRROR

1000mm

FEATURE STORAGE UNITS

Height:
450mm

Depth:
450mm

Door length:
447mm



400mm
450mm
500mm



1000mm

WARDROBE ACCESSORIES

CORNICE

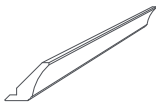

CLASSIC CORNICE

3050 x 66 x 76mm

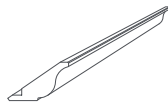

MOULDED CORNICE

3050 x 70 x 109mm

PLINTH

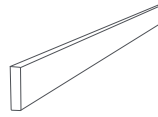

CLASSIC PLINTH

3050 x 100 x 19mm

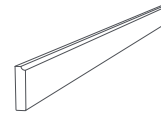

MOULDED PLINTH

3050 x 100 x 25mm

CUSTOM FIT PLINTH

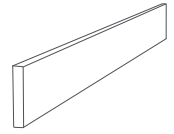

CUSTOM FIT PLINTH

3050 x 160 x 19mm

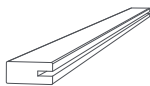

FEATURE POST 2400MM

1 x 2400 x 50 x 100mm

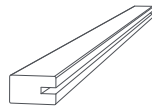

FEATURE POST 3050MM

1 x 3050 x 50 x 100mm



SMALL PASSE-PARTOUT PACK

3 x 2400 x 50 x 100mm

LARGE PASSE-PARTOUT PACK

2 x 2400 x 50 x 100mm
1 x 3050 x 50 x 100mm



CUSTOM FIT TOP WITH COVING

Colour matched top - 2400 x 650 x 19mm
Oak top - 2260 x 750 x 22mm



EDGING TAPE

5000 x 23 x 0.5mm



END PANEL

2400 x 650 x 19mm



CUSTOM FIT END PANEL

2260 x 750 x 22mm

CHESTS

Choose from unassembled or pre-assembled for the entire classic chest collection



2 DRAWER BEDSIDE

486mm width x 576mm height
x 488mm depth



3 DRAWER BEDSIDE

486mm width x 754mm height
x 488mm depth



2 + 2 DRAWER

907mm width x 754mm height
x 488mm depth



4 + 2 DRAWER

907mm width x 1120mm height
x 488mm depth

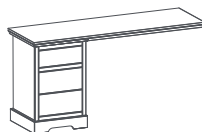

CUSTOM FIT DESK

2400mm width x 754mm height
x 650mm depth



DRESSING TABLE

1500mm width x 754mm height
x 488mm depth

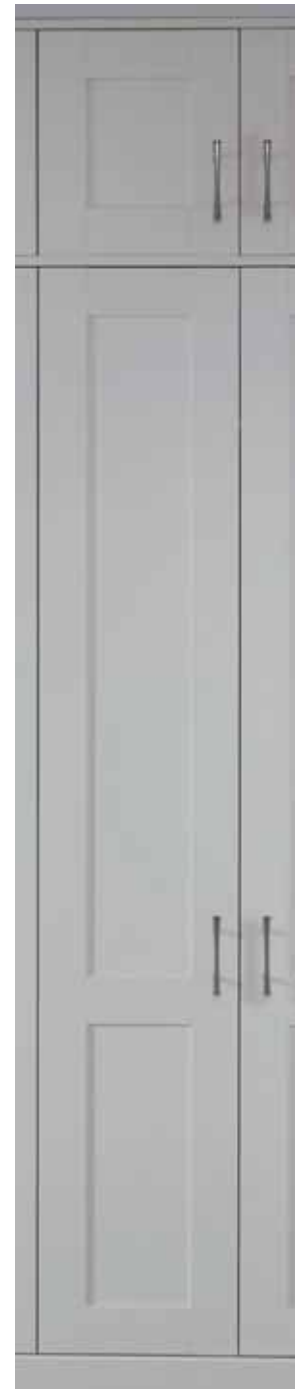



Modern

COLLECTION

Those who love modern design relish where simplicity and functionality are effortlessly entwined. The modern collection embodies sleek design and cutting-edge style, coupled with an ultra-modern and stylish colour palette, to add a unique twist to your dream bedroom.

Available in Cashmere, Dove Grey and White in both matt and gloss painted finishes, and Anthracite in matt only.



Parity

MODERN COLLECTION



Doors: Parity

Painted finish: Matt White

Handle: Cheadle from the Stainless Steel Collection (KDH3001) *Colour matched handles also available



Doors: Parity
Painted finish: Matt Anthracite
Handle: Askern from the Black Collection (KDH3005)

Parity

MODERN COLLECTION

The perfect canvas to develop your individual style, these timeless slab doors are simple yet versatile, whilst the painted finish adds a touch of luxury to a popular door. With its simple form and linear appearance, Parity can adapt to any space. Available in gloss or matt, Parity allows you to create everything from the most minimal of looks, to the most glamorous of boudoirs.



Parity doors in Matt Cashmere



Parity doors in Gloss Dove Grey with Chancery handles from the Timber Collection (KDH3034)



Parity wardrobe showing the stable door with a modern 4 drawer chest

Available in



CASHMERE
MATT/GLOSS



DOVE GREY
MATT/GLOSS

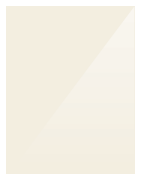

WHITE
MATT/GLOSS



ANTHRACITE
MATT ONLY

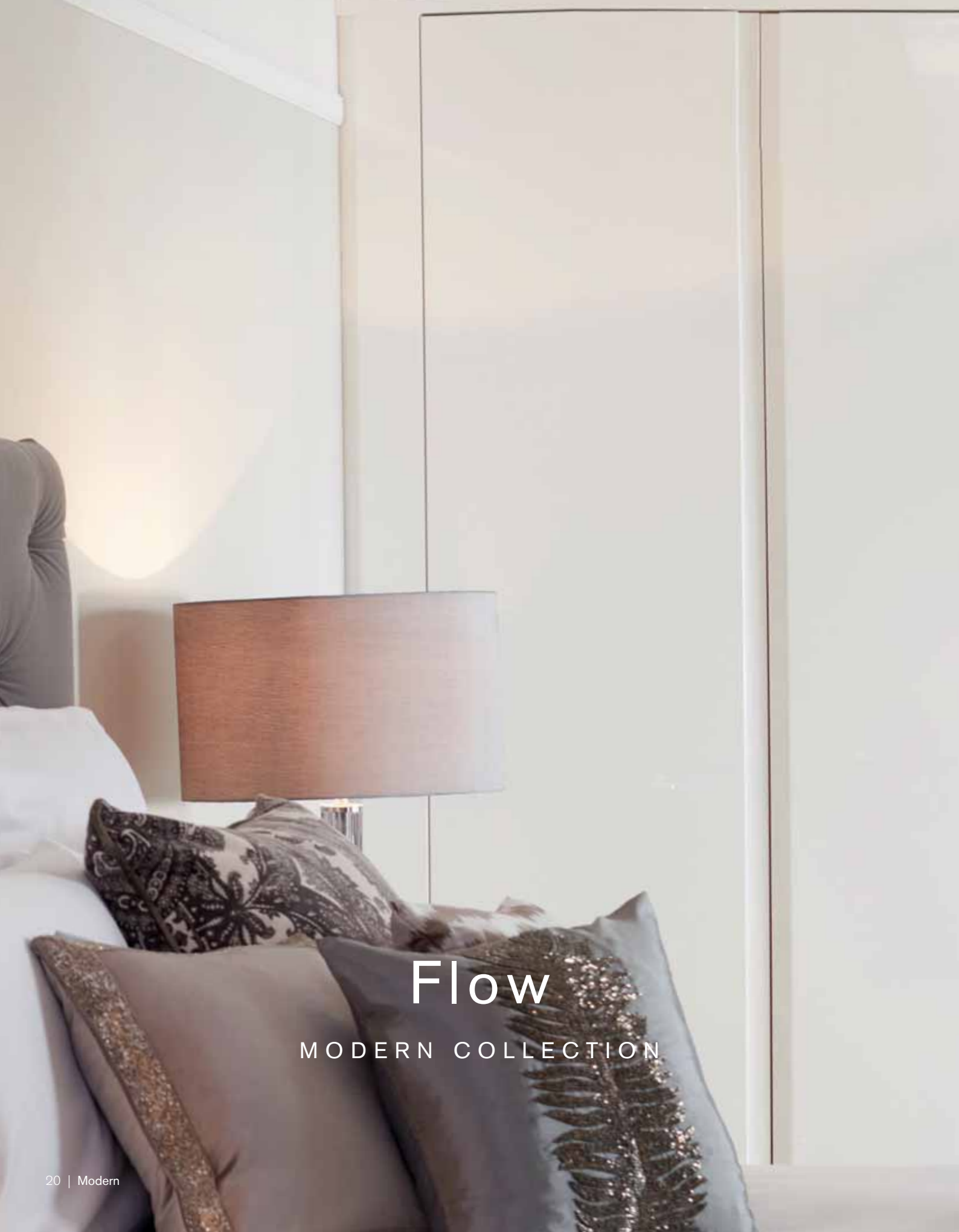

Flow

MODERN COLLECTION



Doors: Flow
Painted finish: Gloss White



Flow

MODERN COLLECTION

Uncomplicated yet striking, this handleless door creates a fluid, streamlined design through uninterrupted lines, easy opening and effortless sophistication. Available in four colours; Anthracite, Dove Grey, White and Cashmere, in both a gloss or matt painted finish, Flow is the perfect base to experiment with contemporary style.



Flow integrated handle detail



Flow Gloss White detail



Flow wardrobe showing standard shelf and hanging rail

Available in



CASHMERE
MATT/GLOSS



DOVE GREY
MATT/GLOSS

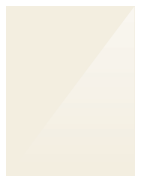

WHITE
MATT/GLOSS



ANTHRACITE
MATT ONLY



Sculpt

MODERN COLLECTION



Doors: Sculpt
Painted finish: Matt White



Sculpt

MODERN COLLECTION

Inspired by Italian design, Sculpt is bold and distinctive. The integrated handle is carefully carved into the centre of the door, creating a strong structural statement. Available in a matt painted finish, in four colours – Anthracite, Dove Grey, White and Cashmere, this range is a powerful statement that works across multiple interior styles.



Sculpt integrated handle detail



Sculpt and Parity mixed wardrobes



Sculpt wardrobe with Walnut stackable drawers and shelves

Available in



CASHMERE
MATT



DOVE GREY
MATT

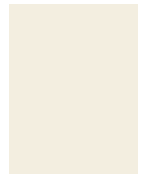

WHITE
MATT



ANTHRACITE
MATT



Esker

MODERN COLLECTION



Doors: Esker

Painted finish: Matt Cashmere

Handle: Cheadle from the Stainless Steel Collection (KDH3001)



Doors: Esker
Finish: Matt Anthracite
Handle: Yeadon from the Black Collection (KDH3015)

Esker

MODERN COLLECTION

Combining classic design principles with contemporary vision, this graceful shaker has been beautifully restyled for the twenty-first century. Carefully crafted and exquisitely shaped to give a distinctive character, the matt-painted finish adds to the sophistication of this range and creates a soft variation within the modern collection. Available in three matt colours – Anthracite, Dove Grey and Cashmere.

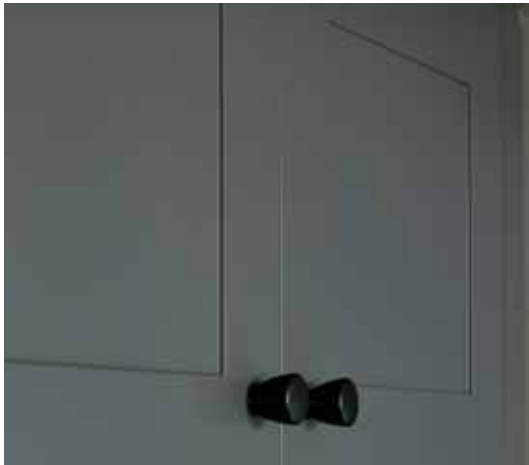

Yeadon handle from the Black Collection (KDH3015 without backplate)



Esker wardrobes shown in Matt Cashmere with handles from the Stainless Steel Collection



Esker wardrobe with mirror doors shown in Matt Cashmere

Available in

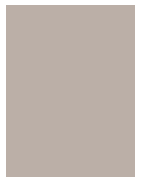

CASHMERE
MATT ONLY

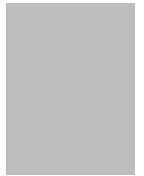

DOVE GREY
MATT ONLY



ANTHRACITE
MATT ONLY

MODERN RANGE OVERVIEW

Parity, Flow and Sculpt
Component and complete

AVAILABLE COLOURS



CASHMERE
MATT & GLOSS

DOVE GREY
MATT & GLOSS

WHITE
MATT & GLOSS

ANTHRACITE
MATT ONLY

*Sculpt is Matt only

COMPONENT - DOORS

<p>Door length: 2218mm</p> <p>Door Depth: 19mm</p>	<p>Door length: 1458mm</p> <p>Door Depth: 19mm</p> <p>Blanking panel length: 794mm</p> <p>Door Depth: 22mm</p>	<p>Door length: 447mm</p> <p>Door Depth: 19mm</p>	<p>Door length: 2218mm</p>	<p>Door length: 2218mm</p>	<p>Door length: 2218mm</p>
SINGLE DOOR	STABLE DOOR	FEATURE DOOR	FEATURE MIRROR	FEATURE GLASS	FEATURE WALNUT
397mm 447mm 497mm	497mm	397mm 447mm 497mm	497mm	497mm	497mm

COMPLETE - WARDROBES

<p>Wardrobe Height: 2260mm</p> <p>Wardrobe Depth: 610mm</p> <p>Door length: 2218mm</p>	<p>Wardrobe Height: 2260mm</p> <p>Wardrobe Depth: 610mm</p> <p>Door length: 2218mm</p>	<p>Wardrobe Height: 2260mm</p> <p>Wardrobe Depth: 610mm</p> <p>Door length: 2218mm</p>	<p>Wardrobe Height: 2260mm</p> <p>Wardrobe Depth: 610mm</p> <p>Door length: 2218mm</p>
SINGLE WARDROBES LH / RH	DOUBLE WARDROBES	CORNER ROBE LH/RH	CORNER STABLE DOOR LH/RH
400mm 450mm 500mm	800mm 900mm 1000mm	1000mm 1150mm including void when fitted	1000mm 1150mm including void when fitted

*Slab only for Parity, Flow and Sculpt

FEATURE WARDROBES

MIRROR / GLASS / WALNUT

LH/RH CORNER ROBE FEATURE	LH/RH DOUBLE FEATURE
1000mm	1000mm

FEATURE STORAGE UNITS

*Slab only for Parity, Flow and Sculpt

<p>Height: 450mm</p>	<p>Depth: 450mm</p>	<p>Door length: 447mm</p>
400mm 450mm 500mm		1000mm

WARDROBE ACCESSORIES

CORNICE

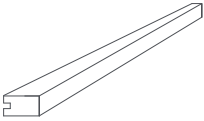

CORNICE

3050 X 28 X 50mm

PLINTH

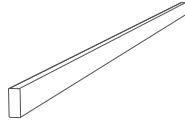

PLINTH

3050 x 36 x 19mm

CUSTOM FIT PLINTH

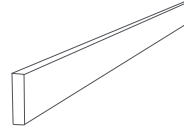

CUSTOM FIT PLINTH

3050 x 160 x 19mm

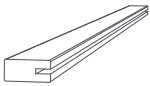

FEATURE POST 2400MM

1 x 2400 x 50 x 100mm

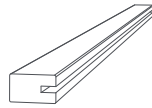

FEATURE POST 3050MM

1 x 3050 x 50 x 100mm



SMALL PASSE-PARTOUT PACK

3 x 2400 x 50 x 100mm

LARGE PASSE-PARTOUT PACK

2 x 2400 x 50 x 100mm
1 x 3050 x 50 x 100mm



END PANEL

2400 x 650 x 19mm



CUSTOM FIT END PANEL

WALNUT / OAK

2260 x 750 x 22mm

CHESTS

Modern chests come fully assembled

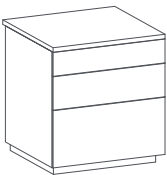

3 DRAWER BEDSIDE

500mm width x 546mm height
x 482mm depth

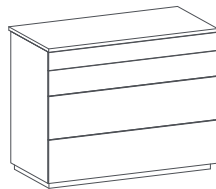

4 DRAWER CHEST

1000mm width x 789mm height
x 482mm depth



MODERN RANGE OVERVIEW

Esker
Component and complete

AVAILABLE COLOURS



CASHMERE
MATT ONLY



DOVE GREY
MATT ONLY



ANTHRACITE
MATT ONLY

COMPONENT - DOORS

Door length:
2218mm
Door Depth:
19mm
Mid Rail Height:
741mm



SINGLE DOOR

397mm
447mm
497mm

Door length:
2218mm
Door Depth:
19mm
Mid Rail Height:
741mm



LH/RH MIRROR

497mm

Door Height:
497mm



FEATURE DOOR

397mm
447mm
497mm

COMPLETE - WARDROBES

Wardrobe Height:
2260mm

Wardrobe Depth:
610mm

Mid Rail Height:
775mm

Door length:
2218mm



SINGLE WARDROBES

400mm
450mm
500mm



DOUBLE WARDROBES

800mm
900mm
1000mm

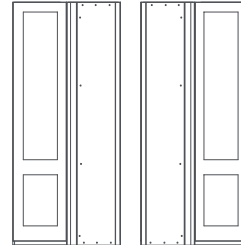

CORNER ROBE LH/RH

1000mm

FEATURE WARDROBES

MIRROR / GLASS / WALNUT



LH/RH MIRROR

500mm



LH/RH DOUBLE MIRROR

500mm

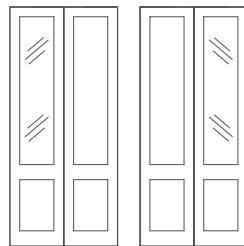

LH/RH MIRROR

500mm



LH/RH CORNER ROBE MIRROR

1000mm
1150mm including void when fitted

FEATURE STORAGE UNITS

Height:
450mm

Depth:
450mm

Door length:
447mm



400mm
450mm
500mm

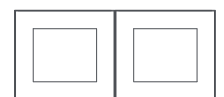

1000mm

WARDROBE ACCESSORIES

CORNICE

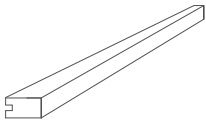

CORNICE

3050 X 28 X 50mm

PLINTH

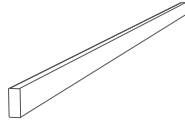

PLINTH

3050 x 36 x 19mm

CUSTOM FIT PLINTH

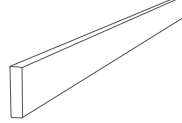

CUSTOM FIT PLINTH

3050 x 160 x 19mm

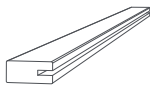

FEATURE POST 2400MM

1 x 2400 x 50 x 100mm

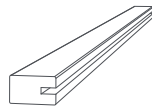

FEATURE POST 3050MM

1 x 3050 x 50 x 100mm



SMALL PASSE-PARTOUT PACK

3 x 2400 x 50 x 100mm

LARGE PASSE-PARTOUT PACK

2 x 2400 x 50 x 100mm
1 x 3050 x 50 x 100mm



END PANEL

2400 x 650 x 19mm



CUSTOM FIT END PANEL

WALNUT / OAK

2260 x 750 x 22mm

CHESTS

Modern chests come fully assembled

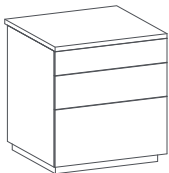

3 DRAWER BEDSIDE

500mm width x 546mm height
x 482mm depth

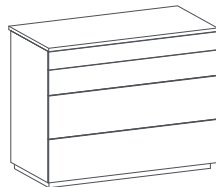

4 DRAWER CHEST

1000mm width x 789mm height
x 482mm depth
**Choose 4 or 8 handles*





Walk-in

COLLECTION



Collection: Walk-in
Finish: Linen Walk-In wardrobe with Parity Matt White accessories and Walnut internals



Walk-in

COLLECTION

Adapting to any space, create the ultimate walk-in closet with our open wardrobes in textured Linen. By combining our wardrobes, with our collection of Walnut, Oak and Linen internal accessories you can customise to any storage requirement.

Frame and finish with Modern or Classic accessories for the ultimate luxurious style.



Pigeon hole in Walnut above 4 drawer Walnut internal bundle



Linen drawer organiser grill



Shoe display in Walnut

Please see
page 40 for
colour choices

Walk-in

Range overview

WARDROBES

Wardrobe Height: **2260mm** Wardrobe Depth: **590mm**

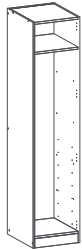

SINGLE WARDROBES

400mm
450mm
500mm

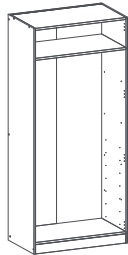

DOUBLE WARDROBES

800mm
900mm
1000mm



WARDROBES ARE ALWAYS IN LINEN

Available colours

FOR EXTERNAL DRESSING OF THE OPEN WARDROBES

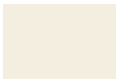

TEXTURED PORCELAIN



TEXTURED PARTRIDGE GREY



TEXTURED STONE



TEXTURED OAK



WALNUT



CASHMERE
MATT & GLOSS



DOVE GREY
MATT & GLOSS



WHITE
MATT & GLOSS



ANTHRACITE
MATT ONLY

*See internal storage section on page 44 for details on the internal options and colours.



Internals

COLLECTION

Clever, flexible and beautiful in design, our wardrobe internals have been carefully considered to work around your needs. Choose from stackable drawers, accent shelves, drawer organisers, shoe storage and pigeon units. Available in Walnut, Oak and Linen finishes.



INTERNALS



SHELVES

Add more storage with 22m thick shelves available in Linen, Oak and Walnut.

Sold in pairs our additional shelves are designed to fit inside all of our wardrobe widths.

HANGING RAIL

Available in a premium Satin Brown finish, our hanging rails perfectly complements the Textured Linen cabinet. Designed to fit the internal size of all of our cabinet widths.



CORNER SHELVING

Further maximise the space available. Available in Linen, our corner shelving unit is the perfect storage solution when trying to maximise cupboard space.

CORNER WARDROBE SHELF PACK

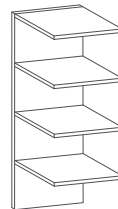



SINGLE STACKABLE DRAWER

With Linen, Walnut and Oak drawer fronts, coupled with a Linen drawer box, our stackable drawers are available in shallow and deep drawer heights and fit inside a 500, 800, 900 and 1000mm wardrobe widths. Place them individually or in multiples within your wardrobe for as much or as little additional storage as you need.

Fully extendable soft close runners as standard add to the premium quality of the additional storage.



BUNDLES

To meet your storage requirements, we have combined individual stackable drawers to create bundles. Choose from 3 and 4 drawer bundles in widths to fit 500, 800, 900 and 1000mm wardrobes.



INTERNALS



DRAWER ORGANISER GRILL

Designed to work perfectly within the 1000mm shallow stackable drawer, this Linen drawer organiser can help to organise your smallest possessions. It can cut to size to work within smaller drawer widths and chests of drawers.



FELT DRAWER LINER

The felt drawer liner comes pre-cut in two widths. Designed to fit the 1000mm stackable drawer, or the 4 drawer modern chest, this soft grey felt liner is the perfect addition to any drawer base. This can be cut to fit smaller drawer widths if you would like to use it within bedside drawers, or smaller stackable drawers.

Working best underneath the Linen drawer organiser grill, the felt drawer liner acts an attractive non-slip solution for items such as sunglasses, watches and jewellery.



PIGEON HOLE

Designed only to suit the 1000mm width wardrobe, the Pigeon hole unit is designed to create a practical yet premium looking storage display for your wardrobe. Use the clever compartments to store perfume bottles, handbags, shoes or folded clothing items for an easy to reach and useful display solution. Available in Linen, Walnut and Oak.





SHOE RACK CONVERSION KIT

This simple element comes only in a Linen finish to match perfectly with the textured Linen cabinet. Supplied in one width – 1000mm with two stabilising end supports. It can be cut down to suit any of our wardrobe widths. Simply place the conversion kit on the bottom of a wardrobe or on shelves for a perfect shoe display.



SHOE DISPLAY

Created with shallow stackable drawers

Why not combine our shoe rack conversion with our shallow height drawers to create a flawless and easy to access shoe storage display.



BUNDLES



BUNDLES

If you can't choose what is best for your storage needs, why not take a look at our predetermined wardrobe bundles available in Linen, Oak and Walnut. Designed to make your life easier we have 10 predetermined bundles for 500, 800 and 900mm wardrobes and 16 predetermined bundles for 1000mm wardrobes. We have done the hard work so you don't have to!

Look out for the best selling wardrobe bundles, as this might help you to decide what will work for you.





HINGED WARDROBE INTERNALS

(wardrobes sold separately)

RANGE OVERVIEW

ACCESSORY FINISH



TEXTURED LINEN



TEXTURED WALNUT



TEXTURED OAK

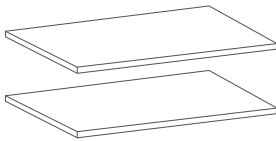

SHELVES

- 364mm
- 414mm
- 464mm
- 764mm
- 864mm
- 964mm



HANGING RAIL

- 364mm
- 414mm
- 464mm
- 764mm
- 864mm
- 964mm

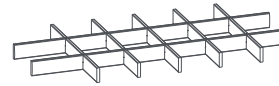

DRAWER ORGANISER GRILL

For 1000mm shallow stackable drawer
- Can be cut down to fit other wardrobes

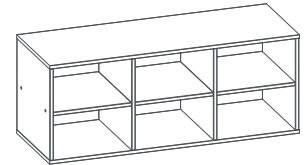

PIGEON HOLE UNIT

For 1000mm wardrobe only

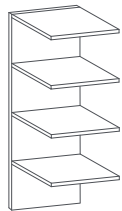

CORNER WARDROBE SHELF PACK

For corner wardrobes
See retailer for more information.



SHOE RACK CONVERSION KIT

1000mm wide
- Can be cut down to fit other wardrobes

STACKABLE INTERNAL DRAWERS

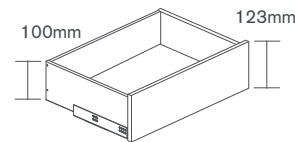

TO SUIT SHALLOW DRAWER

- 500mm
- 800mm
- 900mm
- 1000mm

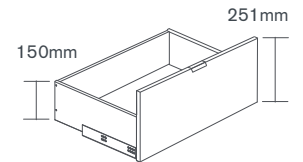

TO SUIT DEEP DRAWER

- 500mm
- 800mm
- 900mm
- 1000mm

3 DRAWER BUNDLE

Bundle Height:
660mm



FOR SINGLE WARDROBES

500mm

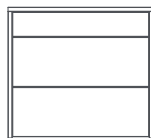

FOR DOUBLE WARDROBES

- 800mm
- 900mm
- 1000mm

4 DRAWER BUNDLE

Bundle Height:
790mm



FOR SINGLE WARDROBES

500mm

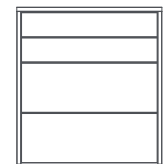

FOR DOUBLE WARDROBES

- 800mm
- 900mm
- 1000mm

HINGED WARDROBE BUNDLES

500mm, 800mm and 900mm (wardrobes sold separately)

RANGE OVERVIEW

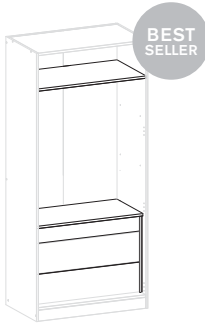

BEST SELLER

BUNDLE 1

- x1 Shallow Stackable Drawer
- x2 Deep Stackable Drawer
- x1 Additional Shelf Pack (x2 Shelves per Pack)

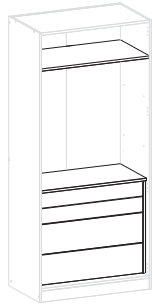

BUNDLE 2

- x2 Shallow Stackable Drawer
- x2 Deep Stackable Drawer
- x1 Additional Shelf Pack (x2 Shelves per Pack)

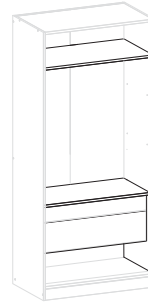

BUNDLE 3

- x1 Shallow Stackable Drawer
- x1 Deep Stackable Drawer
- x1 Additional Shelf Pack (x2 Shelves per Pack)

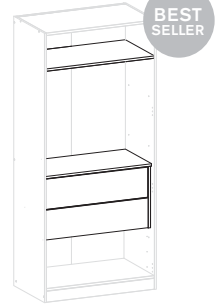

BEST SELLER

BUNDLE 4

- x2 Deep Stackable Drawer
- x1 Additional Shelf Pack (x2 Shelves per Pack)

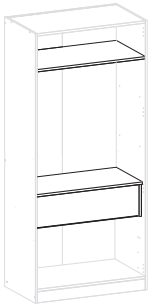

BUNDLE 5

- x1 Deep Stackable Drawer
- x1 Additional Shelf Pack (x2 Shelves per Pack)



BEST SELLER

BUNDLE 6

- x3 Additional Shelf Pack (x2 Shelves per Pack)

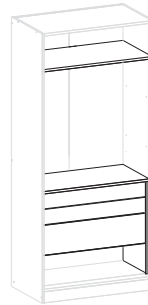

BUNDLE 7

- x2 Shallow Stackable Drawers
- x1 Deep Stackable Drawer
- x1 Additional Shelf Pack (x2 Shelves per Pack)

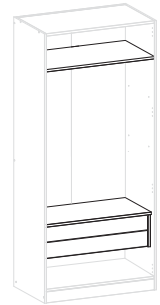

BUNDLE 8

- x2 Shallow Stackable Drawers
- x1 Additional Shelf Pack (x2 Shelves per Pack)

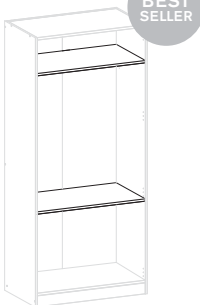

BEST SELLER

BUNDLE 9

- x1 Additional Shelf Pack
- x1 Hanging Rail (x2 Shelves per Pack)

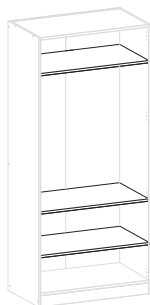

BUNDLE 10

- x2 Additional Shelf Pack (x2 Shelves per Pack)

See page 52 for 1000mm Bundles

HINGED WARDROBE BUNDLES

1000mm (wardrobes sold separately)

RANGE OVERVIEW



BUNDLE 1

- x1 Shallow Stackable Drawer
- x2 Deep Stackable Drawer
- x1 Additional Shelf Pack (x2 shelves per pack)

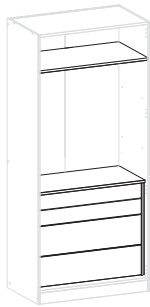

BUNDLE 2

- x2 Shallow Stackable Drawer
 - x2 Deep Stackable Drawer
 - x1 Additional Shelf Pack (x2 shelves per pack)
- * Please note the Linen option includes 1x linen panel to modify robe, not a custom fit panel.

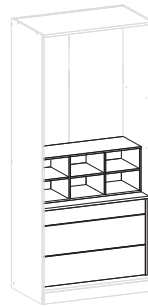

BUNDLE 3

- x1 Shallow Stackable Drawer
- x2 Deep Stackable Drawer
- x1 Additional Shelf Pack (x2 shelves per pack)
- x1 Pigeon Hole Unit

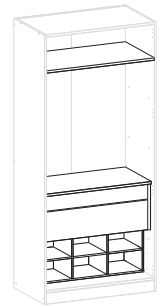

BUNDLE 4

- x1 Shallow Stackable Drawer
- x1 Deep Stackable Drawer
- x1 Additional Shelf Pack (x2 shelves per pack)
- x1 Pigeon Hole Unit



BUNDLE 5

- x2 Deep Stackable Drawer
- x1 Additional Shelf Pack (x2 shelves per pack)

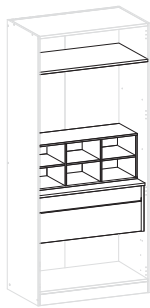

BUNDLE 6

- x1 Shallow Stackable Drawer
- x1 Deep Stackable Drawer
- x1 Additional Shelf Pack (x2 shelves per pack)
- x1 Pigeon Hole Unit

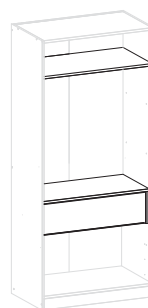

BUNDLE 7

- x1 Deep Stackable Drawer
- x1 Additional Shelf Pack (x2 shelves per pack)

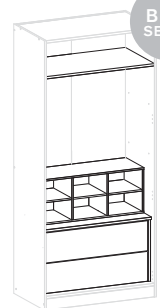

BUNDLE 8

- x2 Deep Stackable Drawer
- x1 Additional Shelf Pack (x2 shelves per pack)
- x1 Pigeon Hole Unit

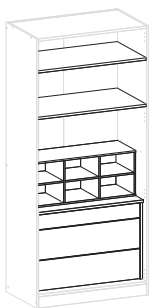

BUNDLE 9

- x1 Shallow Stackable Drawer
- x2 Deep Stackable Drawer
- x2 Additional Shelf Pack (x2 shelves per pack)
- x1 Pigeon Hole Unit

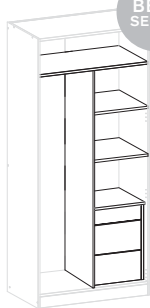

BUNDLE 10

- x1 500mm wide Shallow Stackable Drawer
 - x2 500mm Deep Stackable Drawer
 - x1 Custom Fit End Panel
 - x2 Additional Shelf Pack (x2 shelves per pack) - 500mm
 - x1 Additional Shelf Pack (x2 shelves per pack) - 1000mm
- * Please note the Linen option includes 1x linen panel to modify robe, not a custom fit panel.

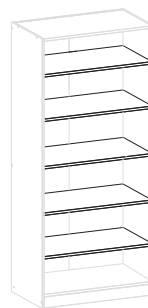

BUNDLE 11

- x3 Additional Shelf Pack (x2 shelves per pack)

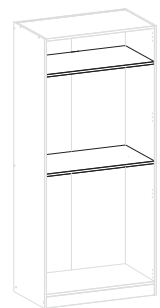

BUNDLE 12

- x1 Additional Shelf Pack (x2 shelves per pack)
- x1 Hanging Rail

HINGED WARDROBE BUNDLES

1000mm (wardrobes sold separately)

RANGE OVERVIEW

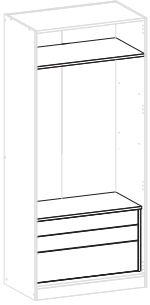

BUNDLE 13

x2 Shallow Stackable Drawer
x1 Deep Stackable Drawer
x1 Additional Shelf Pack (x2 shelves per pack)

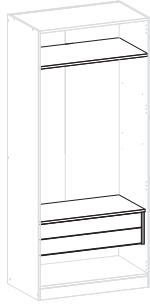

BUNDLE 14

x2 Shallow Stackable Drawer
x1 Additional Shelf Pack (x2 shelves per pack)

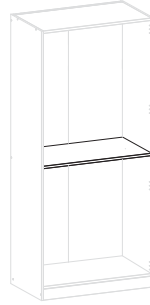

BUNDLE 15

x 1 Additional Shelf Pack (x2 shelves per pack)
x1 Hanging Rail

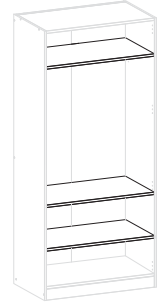

BUNDLE 16

x2 Additional Shelf Pack (x2 shelves per pack)





Made-to-Measure

COLLECTION

Our Made-to-Measure bedroom collection offers you a wide variety of materials and colours for the ultimate design flexibility.

Whether it's a solution to utilise space or fit within a room with a sloping or high ceiling, our selection of ultra-contemporary to classic door styles is perfect for creating a personalised look in any bedroom.



Doors: Bolam
Finish: Supermatt Porcelain
Handle: Highbury from the Black Collection (BH1138.160.MB)



Alpina

MADE-TO-MEASURE COLLECTION



Doors: Alpina
Finish: Deep Oak Matt
Handle: Eldon from the Brown and Copper Collection (KDH3006)

Chest: Modern Matt Cashmere
Handle: Eldon from the Brown and Copper Collection (KDH3006)



Doors: Alpina and Parity
Finish: Natural Oak Matt and Matt White
Handle: Cheadle from the Stainless Steel Collection (KDH3001)

Alpina

MADE-TO-MEASURE COLLECTION

Add sophisticated style to any contemporary bedroom with our new Alpina range. These premium real timber veneer doors are designed to be mixed with other frontals to create a stunning, unique look.



NATURAL OAK
MATT



SMOKED LARCH
MATT



MID OAK



BURNT ASH



DEEP OAK
MATT

Alpina

Made-to-Measure range overview

AVAILABLE COLOURS

MATT FINISHES



NATURAL OAK
(Horizontal grain)



DEEP OAK
(Horizontal grain)

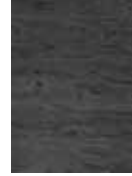

BURNT ASH
(Horizontal grain)

TEXTURED FINISHES



SMOKED LARCH
(Horizontal grain)



MID OAK
(Vertical grain)

ALPINA PARAMETERS

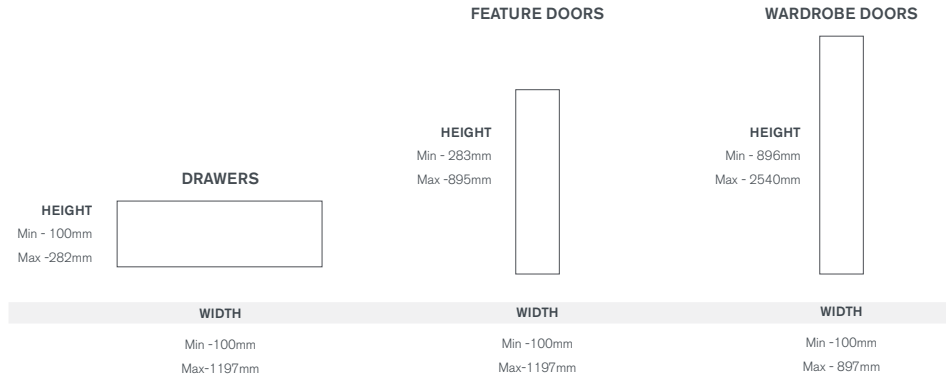

RECOMMENDED COMBINATIONS

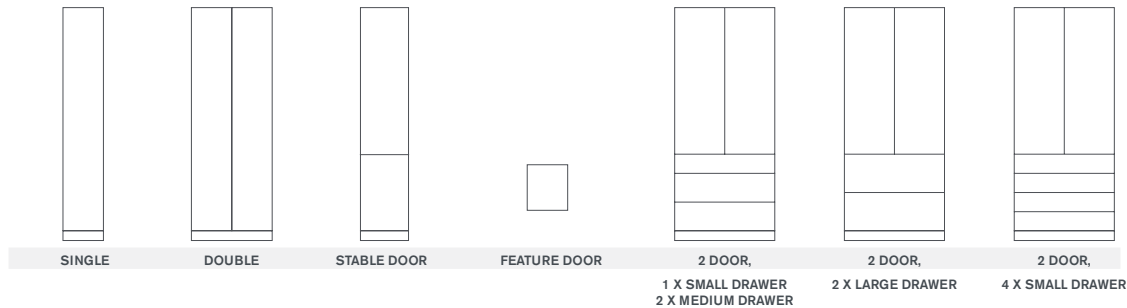

WARDROBE ACCESSORIES

CORNICE

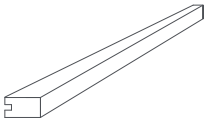

MODERN CORNICE/LIGHT PELMET,

3050x50x18mm

PLINTH

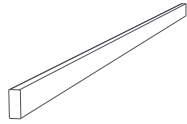

PLINTH

3050x150x18mm

CORNER POSTS



FEATURE STORAGE CORNER POST,

*Please use a plinth
to create a corner post*



WARDROBE CORNER POST

*Please use a plinth
to create a corner post*

FEATURE END POST

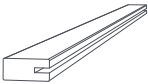

FEATURE END POST,

2400x100x50mm

END PANEL



END PANEL

with square edges,gloss finish on face
only, 2400x650x18mm

EDGING TAPE

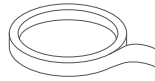

VENEER LACQUERED EDGING

3000x32x0.8mm



Stanhope

MADE-TO-MEASURE COLLECTION



Doors: Stanhope; Elsdon
Finish: Blue Canvas
Handle: Linton from the Chrome Collection (BH1120.256.CH)



Doors: Stanhope; Bolam
Finish: Supermatt Porcelain
Handle: Highbury handle from the Black Collection (BH1138.160.MB)

Stanhope

MADE-TO-MEASURE COLLECTION

A fully Made-to-Measure vinyl door collection available in five door styles with a choice of matt and gloss colours to achieve both modern and classic looks.

An array of supporting accessories and angled doors make this collection ideal for bedrooms.

Please see page 66 for colour finishes.



Elsdon Blue Canvas



Made-to-Measure dressing table solution



Bolam angled wardrobe doors in Supermatt Porcelain with Highbury handle from the Black Collection (BH1138.160MB)

STANHOPE CLASSIC COLLECTION



ELSDON
4 PANEL
1 PIECE SHAKER

BOLAM
1 PIECE SHAKER



AVAILABLE IN
ANGLED DOORS

MATT



PORCELAIN



STONE



ALABASTER



BLUE
CANVAS



MUSSEL



CASHMERE



DOVE GREY



GRAPHITE

WOODGRAIN



SUPER WHITE



CREAM



GREY



MUSSEL



CASHMERE

STANHOPE MODERN COLLECTION

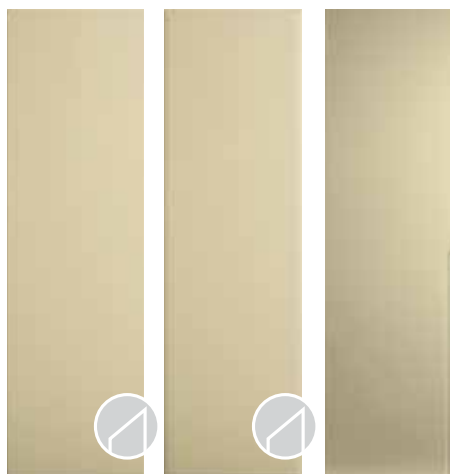

WHITFIELD
SQUARE SLAB

HENSHAW
SAPPONETTA
SLAB

ACOMB
INTEGRATED
HANDLE

*Not available
in Gloss*



AVAILABLE IN
ANGLED DOORS

GLOSS



WHITE



CREAM



HAZE
(WHITE
BACK)

MATT



PORCELAIN



STONE



ALABASTER



MUSSEL



CASHMERE



DOVE GREY



BLUE CANVAS



GRAPHITE

FEATURE



CONCRETE
(LIGHT GREY
BACK)

WOODGRAIN



SUPER
WHITE



CREAM



GREY



MUSSEL



CASHMERE

Stanhope

Made-to-Measure range overview

DOOR FRONTALS

Classic

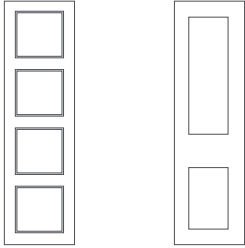

ELSDON LH/RH

BOLAM LH/RH

4 panel - 1 piece shaker

1 piece shaker

Modern

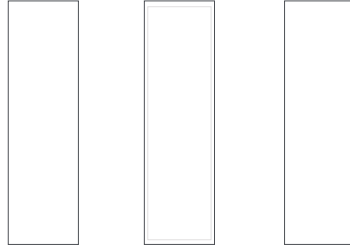

WHITFIELD

HENSHAW

ACOMB LH/RH

Square Slab

Sapponetta Slab

Integrated handle

DOOR/DRAWER SIZE PARAMETERS

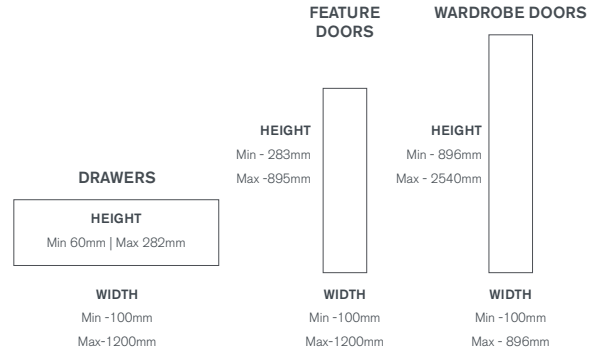

RECOMMENDED COMBINATIONS

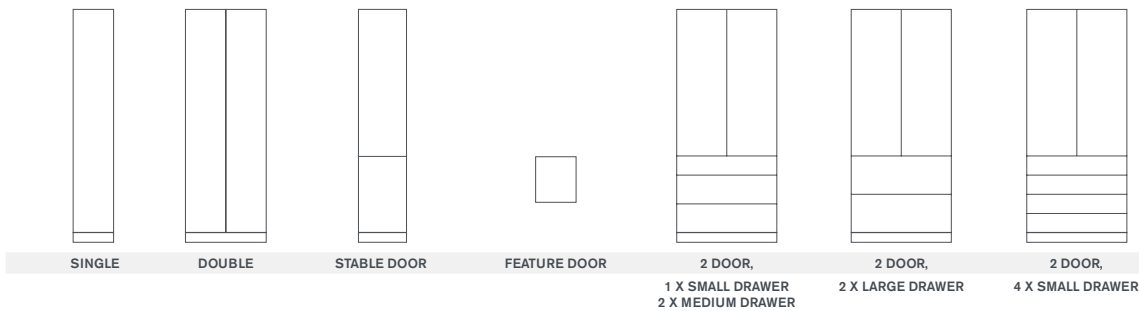

SIZE PARAMETERS EXPECTATIONS

BOLAM

Minimum door width with internal Shaker design - 275mm

ACOMB:

Minimum drawer/door width - 240mm. Integrated handle profile on drawer fronts and doors below 1699mm high have a 200mm long groove on the top. Doors above 1700mm high have a 900mm long groove on the left/right hand side.

ELSDON:

Minimum drawer height with internal Shaker design - 160mm
Min drawer width with internal design - 230mm
Min door width with internal design - 230mm

GRAIN DIRECTION

- Drawer fronts are supplied with horizontal grain as standard
- Feature and wardrobe doors are supplied with vertical grain in all finishes except Gloss Haze which is horizontal on all drawers/doors.

DOORS FOR CORNER CABINETS

Doors can be supplied with either left or right side edge square. Available up to Max. 1699mm high.

WARDROBE DOORS

Wardrobe door designs with two panels will be supplied with the mid rail at 655mm from the bottom edge to the centre of the mid rail as standard unless otherwise specified.

ANGLED DOORS

Not available in Elsdon and Acomb

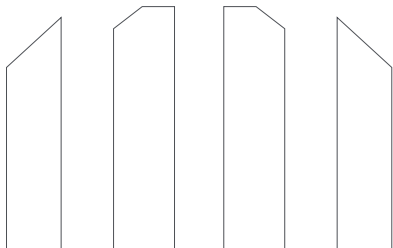

OPEN FRAMED DOORS

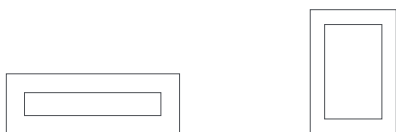

	HEIGHT	WIDTH	HEIGHT	WIDTH
MIN	175mm	296mm	283mm	296mm
MAX	354mm	1200mm	1699mm	650mm

The below open framed doors are available in 3 options:

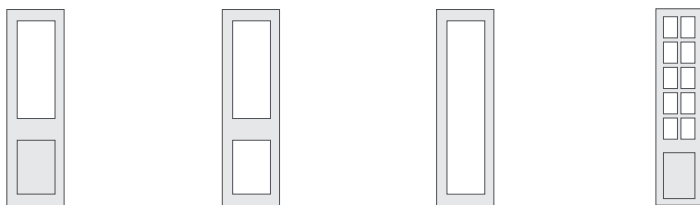

TOP OPEN TOP AND BOTTOM OPEN FULL OPEN FRAME GEORGIAN

Not available in Elsdon, Acomb or high gloss

Glazing options:

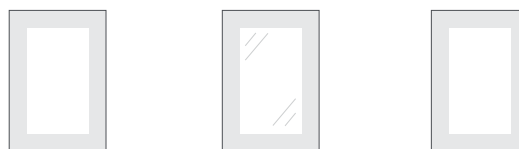

FRAME ONLY CLEAR FROSTED

No glazing

Glass

Glass

AVAILABLE COLOURS

All finishes are supplied with matching back except where indicated below

Classic - Elsdon and Bolam

MATT



Porcelain Stone Alabaster Blue Canvas Mussel



Cashmere Dove Grey Graphite

WOODGRAIN



Super White Cream Grey Mussel Cashmere

Modern - Whitfield, Henshaw and Acomb

GLOSS - Acomb not available in gloss



White Cream Haze (White Back)

FEATURE



Concrete (Light Grey Back)

MATT



Porcelain Stone Alabaster Blue Canvas Mussel Cashmere Dove Grey Graphite

WOODGRAIN



Super White Cream Grey Mussel Cashmere

Stanhope Accessories

Made-to-Measure range overview

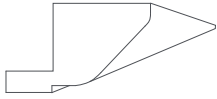

TANGENT CORNICE*

45mm High when fixed.
3050mm length

* Not available in Gloss Haze or Concrete

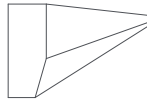

TANGENT LIGHT PELMET*

57mm High when fixed. 3050mm length
* Not available in Gloss Haze or Concrete

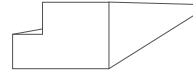

MULTI PURPOSE RAIL

55mm x 36mm
x 3050mm length

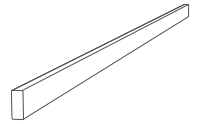

PLINTH

Can be supplied any height between 100-200mm
2540mm length



CORNER POST

Please use a plinth
to create a corner post



FLUTED PILASTERS

900x100x18mm
2540x100x18mm



MODERN PILASTERS

900x100x18mm
2540x100x18mm



BARREL PILASTER

900x93x46mm

* Not available in Gloss

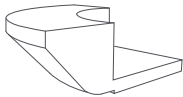

RADIUS CORNICE PIECE

(Tangent) 120mm x 120mm

* Not available in Gloss Haze or
Concrete

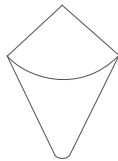

RADIUS RAIL

80mm x 34mm x 3050mm length

* Not available in Gloss Haze or
Concrete

Can be used for various applications
including cornice, gable ends, pilasters etc.



PRE-GLUED EDGING TAPE

22mm X 50M

Gloss Colours have a matt finish except for
Gloss White. Not available in Matt Blue Canvas



PLAIN END PANEL

18 or 25mm thick.
Up to 2540x897mm
25mm panels supplied
with cream reverse

For parameters please see page 68



T&G END PANEL

18 or 25mm thick.
Up to 2540x897mm
25mm panels supplied
with cream reverse

* Not available in Gloss colours



End panel to ceiling



Plinth used as infill to ceiling



Plinth



25mm end panel as a desk top



Plinth used to create corner post



Unity

MADE-TO-MEASURE COLLECTION



Doors: Unity
Finish: Supermatt Pure White
Handle: Soho from the White Collection - BH1131.250.MW



Doors: Unity
Finish: Supermatt White
Handle: Showing Yard (BH1137.160.MW) and Soho (BH1131.90.MW) from the White Collection

Unity

MADE-TO-MEASURE COLLECTION

Our Unity collection offers genuine bespoke bedroom furniture to fit your space perfectly.

Select from 20 ultra-contemporary shades across lustrous high gloss, smooth supermatt, gloss metallic and woodgrain finishes.

Please see page 76 for colour finishes.



Supermatt White feature storage doors with matching edge



White Halifax Oak floating dressing table



White Halifax Oak floating bedside with matching edge

2 edge options available



Matching AirTech Edge



Two-Tone 3D glass effect
(Gloss and metallic doors only)

UNITY COLLECTION

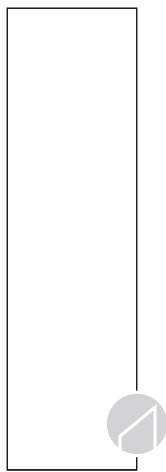

ONE DOOR
STYLE



AVAILABLE IN
ANGLED DOORS

EDGE OPTIONS



MATCHING AIRTECH EDGE



TWO-TONE 3D GLASS EFFECT
(GLOSS AND METALLIC
DOORS ONLY)

WOODGRAIN EFFECT (Matching edge only)



GLOSS FINISHES



GLOSS METALLIC FINISHES

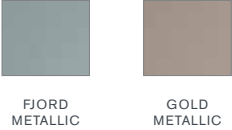

FEATURE CONCRETE



SUPERMATT FINISHES (Matching edge only)



Unity

Made-to-Measure range overview

EDGE OPTIONS

UNITY made-to-measure is available in 2 edge options.



MATCHING AIRTECH EDGE



TWO-TONE 3D GLASS EFFECT
(Gloss doors only)

UNITY PARAMETERS

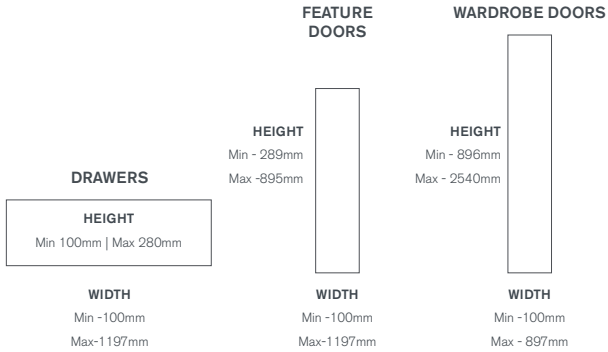

ANGLED DOOR DESIGNS

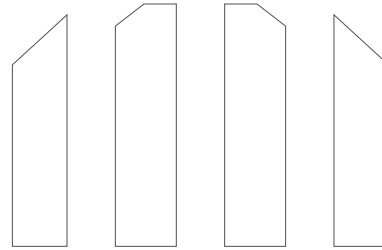

RECOMMENDED COMBINATIONS

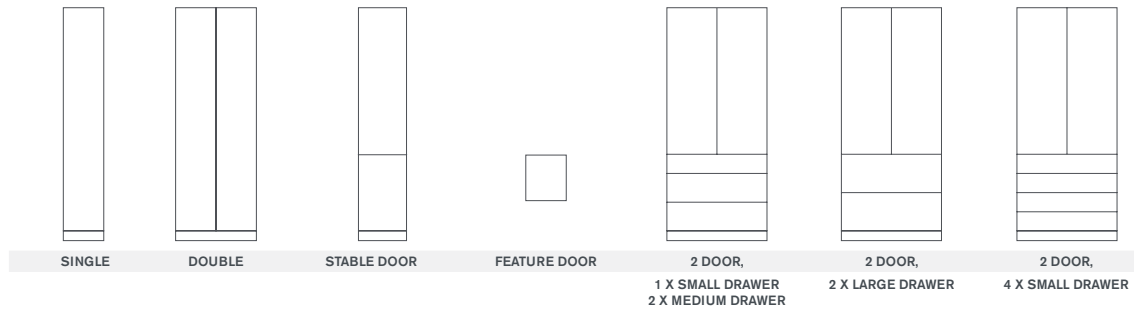

AVAILABLE COLOURS

GLOSS

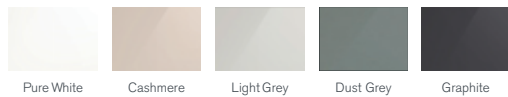

GLOSS METALLIC

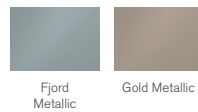

NEW FEATURE CONCRETE

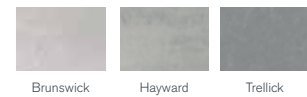

SUPERMATT

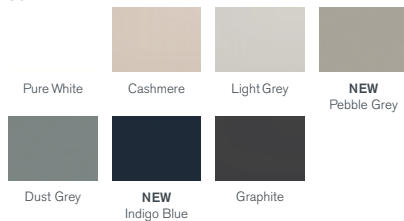

WOODGRAIN EFFECT



WARDROBE ACCESSORIES

CORNICE

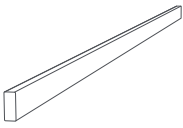

PLINTH

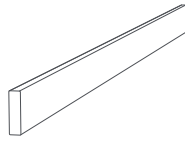

CORNER POST

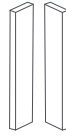

END PANEL



MODERN CORNICE/LIGHT PELMET

3000x70x18mm, edged one long side only with a blank finish on the hidden face

Pelmet and plinth are edged on one long side only with a matching edge.

(Woodgrain is 2800x70x18)

PLINTH

3000x150x18mm, edged one long side only with a blank finish on the hidden face

Pelmet and plinth are edged on one long side only with a matching edge.

(Woodgrain is 2800x150x18)

CORNER POST

Please use a plinth to create a corner post

END PANEL

End panels are available to order as a standalone product type in the same made-to-measure sizes as doors. End panels are supplied in a matching edge only and edged all 4 sides as standard.

For sizes please see Unity Parameters.



End panel used to create kick board and shelf for custom desk.
Supermatt White, woodgrain effect black



End panel used to create feature head board behind bed.
Woodgrain effect in Black.



Sliding

MADE-TO-MEASURE COLLECTION



Frame: Satin Silver - Shape
Doors: Full panel and equal 3 panel design
Finish: Silver mirror and Anthracite glass



Frame: Satin Silver - Cube
Doors: Equal 2
Painted finish: White Glass

Sliding

MADE-TO-MEASURE COLLECTION

Our range of sliding doors enable maximum space whether it's a loft of sloping eaves, impressive heights of Georgian ceilings, or a quaint cottage footprint. Truly bespoke in function, we offer an extensive range of glass, satin glass, mirror and panel options.



FULL PANEL



EQUAL TWO



LOW 400



CENTRAL 400



EQUAL THREE



WIDE 400



WIDE 300

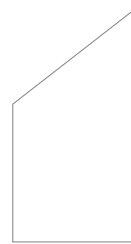

ANGLED DOORS
AVAILABLE



Full panel, mixed Gloss Cashmere board and Matt White board.



Wide 400, Matt Cashmere board and Satin Stone glass



Liner

Top track

Doors

Rail Profile

Liner

Runners/wheels

Liner

Bottom track

Modern Gloss Chest

Frame profile and colour

Choose from five different frame shapes and six different colour options to tailor your wardrobe to your personal taste.



FRAME PROFILE COLOURS

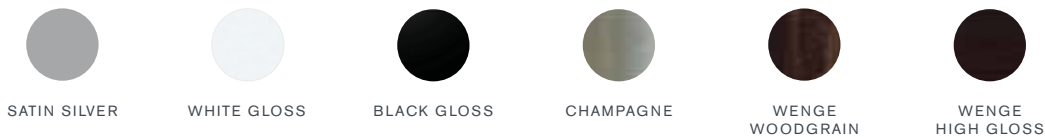

Door colours for your chosen door style.

Choose from over 30 door colour options ranging from glass, satin glass, mirror, matt, gloss and textured woodgrain boards.



End panels and liners

If your wardrobe is being placed wall to wall you will only require liners but if you require one or two ends open, you will need to choose an end panel as well as a liner. You can choose from matt and gloss coloured board or woodgrain board to frame your wardrobe.

If you need a bit of help on what colours complement each other, why not take a look at our board match chart.

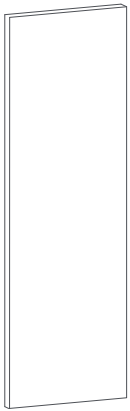

End panel



Liner

BOARD COLOURS



WOODGRAIN BOARDS



TEXTURED

Textured linen end panels and liners are only recommended for internals.

Internals

Whether you simply want a shelf and hanging rail or something a bit more, you can tailor the internals depending on your storage needs.



SHELF AND HANGING RAIL

The shelf and hanging rail is a fixed size unit at 2500mm wide x 620mm deep.

It comes with colour matched batons which fix to the walls and a 25mm chrome hanging rail and vertical pole support.

If your wardrobe is smaller than 2500mm the shelf and hanging rail can simply be cut to size. If your wardrobe is greater than 2500 you can get multiples of the shelf and hanging rail and put an end panel between them for stability.

BOARD COLOURS



TEXTURED

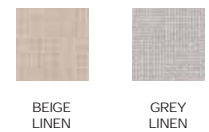

WOODGRAIN BOARDS



HANGING RAIL



Board match chart

Where possible we created Sliding colour matches to our other ranges, Chapter, Origin, Sculpt, Esker, Flow and Parity. Please use table below.

These finishes are relating to the Modern collection: Modern Chests, Sculpt, Parity, Flow, Esker

MODERN - MATT		White	Cashmere	Dove Grey	Anthracite
SLIDING FINISHES	Glass Colour - 8mm	White	Cashmere	N/A	Anthracite
	Satin Glass Colour - 8mm	Satin White	Satin Cashmere	N/A	Satin Anthracite
	Board Colour - 8mm	Matt White	Matt Cashmere	Matt Dove Grey	Matt Anthracite
	End Panels & Liner - 18mm	Matt White	Matt Cashmere	Matt Dove Grey	Matt Anthracite
	Internal Colour - 18mm	Matt White	Matt Cashmere	Matt Dove Grey	Matt Anthracite

MODERN - GLOSS		White	Cashmere	Dove Grey
SLIDING FINISHES	Glass Colour - 8mm	White	Cashmere	N/A
	Satin Glass Colour - 8mm	Satin White	Satin Cashmere	N/A
	Board Colour - 8mm	Gloss White	Gloss Cashmere	Matt Dove Grey
	End Panels & Liner - 18mm	Gloss White	Gloss Cashmere	Matt Dove Grey
	Internal Colour - 18mm	N/A	N/A	N/A

These finishes are relating to the Classic collection: Classic Chests, Chapter and Origin

CLASSIC		Porcelain	Partridge Grey	Stone
SLIDING FINISHES	Glass Colour - 8mm	N/A	Classic Grey	Cashmere
	Satin Glass Colour - 8mm	N/A	N/A	Satin Cashmere
	Board Colour - 8mm	Classic Porcelain	Classic Grey	Classic Stone
	End Panels & Liner - 18mm	Classic Porcelain	Classic Grey	Classic Stone
	Internal Colour - 18mm	N/A	N/A	N/A

TO MATCH;

Sliding door finishes with end panels and internals.

Only use the Grey section of Sliding Finishes which is highlighted on the left. View vertically to see what recommendations we have to the closest match when choosing your sliding doors and accessories finishes.

TO MATCH;

Hinged wardrobes or Chest finishes with sliding finishes.

Use both the top of the tables along with the sliding finishes. View vertically to see which Sliding finishes, end panels/fillet and internal colours are the best match for your chosen finish.

Sliders

RANGE OVERVIEW

ANGLED SLIDING
DOORS AVAILABLE

DOOR DESIGNS

MAXIMUM DOOR HEIGHT 2500mm / DOOR WIDTH 600mm-1100mm

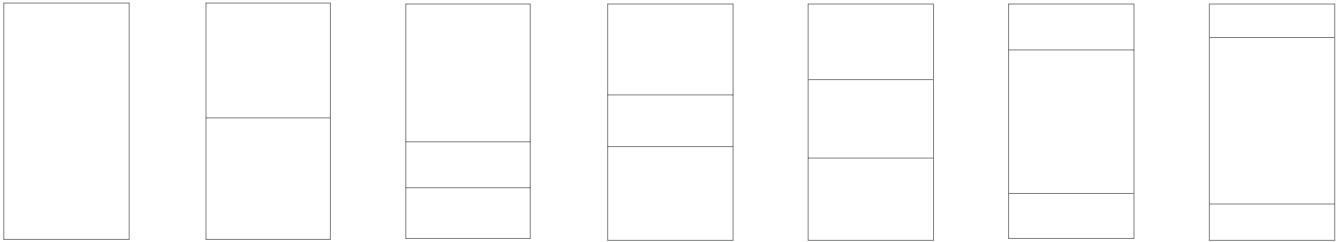

FULL PANEL EQUAL TWO LOW 400 CENTRAL 400 EQUAL THREE WIDE 400 WIDE 300

ALUMINIUM PROFILES



PRISM



FIGURE



CURVE



CUBE



SHAPE

PROFILE COLOUR RANGE



SATIN SILVER



CHAMPAGNE



WHITE GLOSS



WENGE WOODGRAIN

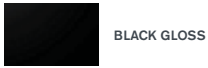

BLACK GLOSS



WENGE HIGH GLOSS

Door
thickness
8mm

Door colours

MIRROR (1)		BOARD COLOURS (2)			WOODGRAIN BOARDS (2)		
SILVER MIRROR		GLOSS - WHITE		MATT - WHITE		CLASSIC PORCELAIN	
BRONZE MIRROR		GLOSS - DOVE GREY		MATT - DOVE GREY		CLASSIC GREY	
GREY MIRROR		GLOSS - CASHMERE		MATT - CASHMERE		CLASSIC STONE	
				MATT - ANTHRACITE		OAK	
						WALNUT	
GLASS COLOURS (3)							
WHITE		CASHMERE		BLUE SHADOW			
RICH ALUMINIUM		DAKAR		ANTHRACITE			
CLASSIC GREY		STONE GREY		AUBERGINE			
		METAL TAUPE		STARLIGHT BLACK			
SATIN GLASS COLOURS (4)							
SATIN WHITE		SATIN CASHMERE		SATIN BRONZE			
SATIN SILVER		SATIN DAKAR		SATIN ANTHRACITE			
SATIN GREY		SATIN STONE GREY		SATIN BLACK			

End panels and Liners

Panel
thickness
18mm

CLASSIC PORCELAIN		GLOSS - WHITE		MATT - WHITE		OAK	
CLASSIC GREY		GLOSS - DOVE GREY		MATT - DOVE GREY		WALNUT	
CLASSIC STONE		GLOSS - CASHMERE		MATT - CASHMERE		BEIGE LINEN	
				MATT - ANTHRACITE		GREY LINEN	

Shelf and hanging rail

Panel
thickness
18mm

SHELF						HANGING RAIL	
CLASSIC PORCELAIN		MATT - WHITE		OAK			
CLASSIC GREY		MATT - DOVE GREY		WALNUT		SILVER	
CLASSIC STONE		MATT - CASHMERE		BEIGE LINEN			
		MATT - ANTHRACITE		GREY LINEN			

TEXTURED LINEN END PANELS
AND LINERS ARE ONLY
RECOMMENDED FOR INTERNALS.

PRICE INDEX

(1) MIRROR (2) PANEL (3) GLASS (4) SATIN GLASS (-) ANGLED DOORS POA



Finishing Touches

A variety of finishing touches designed to customise your dream bedroom. Explore our collection of internal storage, choose from our traditional and contemporary chests, or complete the look with our painted bed frame.

With an extensive selection of over 150 handles you can tailor your bedroom to suit your individual style.

Handles	92
Lighting	108
Chests	114
Bed Collection	124



Handle

COLLECTION

The finer details can truly pull your room together, that's why it's important for us to offer you an extensive yet considered handle collection. Enhancing both classic and modern styles, you can now choose from over 150 handle choices.

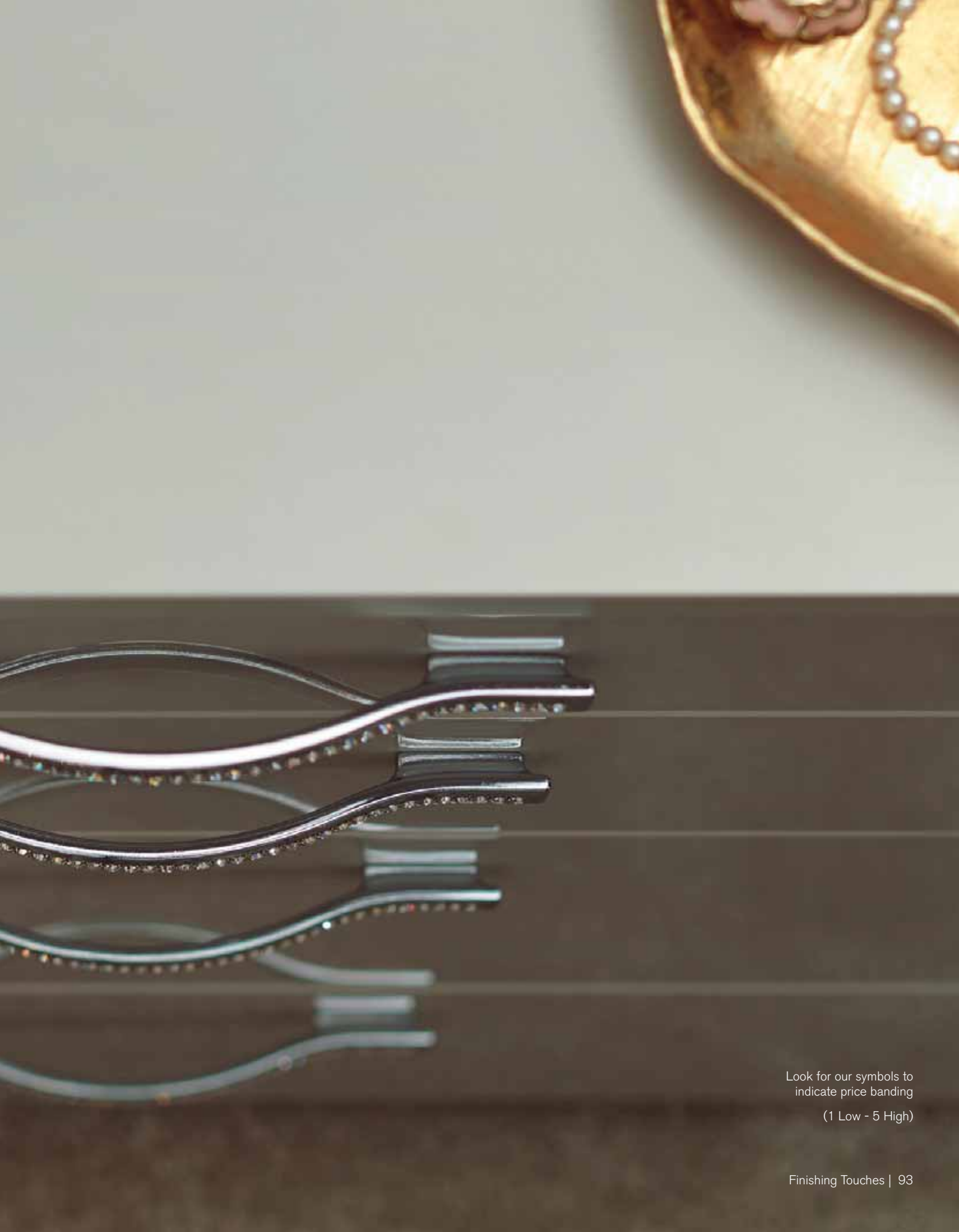

Look for our symbols to
indicate price banding
(1 Low - 5 High)



STAINLESS STEEL EFFECT



Arlington
Bar Handle
1 BH503.128.SS



Dartmouth
Bar Handle
4 BH1128.160.SS



Portland
Cup Handle
1 B1003/79SS



Arlington
T-Bar Handle
1 BH503.60.SS



Dartmouth
T-Bar Handle
2 BH1123.60.SS



Portland
Knob Handle
1 BTK2SS



Cheadle
Block Handle
128mm - **2** KDH3000
192mm - **2** KDH3001



Clerkenwell
Trim Handle
2 BH1124.96.SS
2 BH1124.256.SS



Wilton
Crystal Knob
2 KDH3014



Marylebone
Teardrop Trim Handle
1 BH1087.32.SS
1 BH1087.160.SS



Guildford
Cup Handle
1 BH1027.32.SS
2 BH1028.64.SS
2 BH1029.128.SS

PRICE BANDS

1 2 3 4 5



NICKEL



Bedford
Bar Handle
5 BH882.160.BN



Chelsea
D Handle
2 BH420.128.DN



Leeming
Bar Handle
2 KDH3010



Bedford
T-Bar Handle
5 BH884.72.BN



Chelsea
Knob Handle
1 BK419.32.DN



Leeming
T-Bar Handle
1 KDH3011



Belgrave
Knob Handle
Satin Nickel
1 BK1107.35.SN



Belgrave
Cup Handle
Antique Nickel
1 B8/952.B.AN

PRICE BANDS
1 2 3 4 5



CHROME



Barton
Cup Handle
1 BH1092.64.CH



Collingwood
Cup Handle
5 BH1127.76.CH



Kensington
D Handle
2 BH768.128.CH



Weel
T-Bar Handle
1 BH1091.60.CH



Chatsworth
Knob Handle
4 BK877.35.CH



Kensington
D Handle
4 BH1044.128.CH



Bloomfield
Bar Handle
3 BH994.160.CH



Hoxton
D Handle
2 BH1085.160.CH



Kensington
Square Handle
4 BK1043.32.CH



Bloomfield
Hexagonal T-Bar Handle
2 BH995.68.CH



Hoxton
Cup Handle
1 BH1108.96.CH



Wellington
Round Knob Handle
with Backplate
5 BK1075.32.CH

PRICE BANDS

1 2 3 4 5



Crystal Bow Handle
3 KDH3008



Linton Bar Handle
2 BH1120.160.CH
3 BH1120.256.CH



Yeadon Square Knob Handle with backplate
2 KDH3017



Crystal D Handle
3 KDH3013
3 KDH3012



Linton T-Bar Handle
2 BH1120.60.CH



Yeadon Round Knob Handle with backplate
4 KDH3016



Crystal Small D Handle
2 KDH3009



Darlington D Handle
2 KDH3027
2 KDH3028



Wath Knob Handle
1 KDH3018



Sutton Flat Handle
1 KDH3030



Fimber D Handle
2 KDH3029

PRICE BANDS
1 2 3 4 5



KNURLED

Stainless Steel

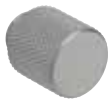

Knob
1 BK1111.20.SS



Knob with backplate
2 BK1111.20B384SS



T-Bar Handle
2 BH1125.35.SS



T-Bar Handle with backplate
3 BH1125.35B385SS

Aged Brass



Knob
1 BK1111.20.AGB



Knob with backplate
2 BK1111.20B384AGB



T-Bar Handle
2 BH1125.35.AGB



T-Bar Handle with backplate
3 BH1125.35B385AGB

Matt Black



Knob
1 BK1111.20.MB



Knob with backplate
2 BK1111.20B384MB



T-Bar Handle
2 BH1125.35.MB



T-Bar Handle with backplate
3 BH1125.35B385MB

PRICE BANDS

1 2 3 4 5



Stainless Steel

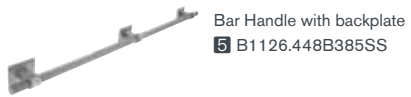
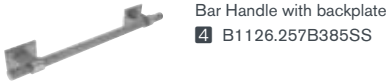

Aged Brass

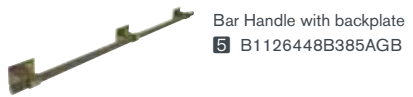
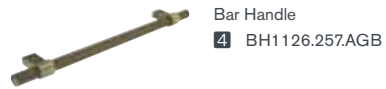

Matt Black

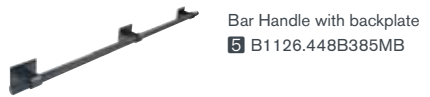

PRICE BANDS
1 2 3 4 5



BLACK



Claremont
D Handle
Industrial Matt Black
2 BH1103.160.MB



Bromley
Bow
Industrial Matt Black
2 BH1129.225.MB



Hoxton
D Handle
Industrial Matt Black
2 KDH3046



Claremont
Cup Handle
Industrial Matt Black
1 BH1105.64.MB



Bromley
Square Knob
Industrial Matt Black
1 BK1112.35.MB



Hoxton
Cup Handle
2 KDH3045



Claremont
Knob
Industrial Matt Black
1 KDH3044



Barton
Cup Handle
Satin Black
1 BH1092.64.BS



Yeadon
Square Knob
with backplate
Satin Black
2 KDH3040



Barton
Round Knob
Satin Black
1 BK1110.33.BS



Yeadon
Round Knob
with backplate
Satin Black
2 KDH3015

PRICE BANDS

1 2 3 4 5



Bloomfield
Hexagonal Bar Handle
Satin Black
2 KDH3019



Disbury
Knurled D Handle
Matt Black
2 BH1140.192.MB



Highbury
Trim Cup Handle
Matt Black
1 BH1138.160.MB



Bloomfield
Hexagonal T-Bar Handle
Satin Black
1 KDH3020



Hove
D Handle
Matt Black
2 BH1130.160.MB
2 BH1130.320.MB



Askern
Geometric D Handle
Satin Black
2 KDH3004
3 KDH3005



Marylebone
Trim Handle
Satin Black
1 BH1087.32.BS
1 BH1087.160.BS
1 BH1087.256.BS

PRICE BANDS
1 2 3 4 5



PEWTER



Berwick
Bar Handle
3 KDH3024



Hampshire
Bow Handle
3 KDH3026



Cromwell
Cup Handle
3 BH1111.64.PE



Berwick
Knob Handle
2 KDH3022



Hampshire
Knob
2 KDH3025



Chatsworth
Knob
3 BK1109.35.PE



Berwick
Knob
with backplate
2 KDH3023



Aztec
Knob
1 KDH3042

PRICE BANDS

1 2 3 4 5



BROWN AND COPPER



Cheadle
Block Handle
128mm - **1** KDH3002
192mm - **1** KDH3003



Eldon
Bar Handle
1 KDH3006
2 KDH3007

PUSH LATCH



Hidden Push Latch
Mechanism for handleless frontals
1 KDH3039

PRICE BANDS
1 2 3 4 5



ANTIQUÉ BRONZE



Claremont
D Handle
2 BH1103.160.BR



Dartmouth
D Handle
4 BH1128.160.AGB



Disbury
Knurled Handle
3 BH1140.192.BR



Claremont
Cup Handle
1 KDH3043



Dartmouth
T-Bar Handle
2 BH1123.60.AGB



Bishop
Bar Handle
1 KDH3047



Claremont
Knob
1 BK1106.30.BR



Wellington
Knob
5 BK1075.32.BR



Hampton
Knob
1 KDH3041

PRICE BANDS

1 2 3 4 5



BRASS HANDLES



Highbury
Cup Handle
Aged Brushed Brass
1 BH1138.64.AGB
2 BH1138.160.AGB
3 BH1138.320.AGB



Yard
D handle
Aged Brushed Brass
1 BH1137.160.AGB
2 BH1137.224.AGB



Hessay
D handle
Brushed Brass
2 BH1133.160.BHB
3 BH1133.320.BHB



Stivichall
Knob
Antique Brass
1 BK266.33.AB

PRICE BANDS
1 2 3 4 5



MATT WHITE



Hove
D Handle
2 BH1130.160.MW
2 BH1130.320.MW



Yard
D handle
1 BH1137.160.MW
2 BH1137.224.MW



Rainton
D handle
2 BH1139.160.MW
2 BH1139.320.MW



Highbury
Cup Handle
1 BH1138.64.MW
1 BH1138.160.MW
3 BH1138.320.MW



Soho
Trim handle
2 BH1131.90.MW
2 BH1131.250.MW

PRICE BANDS

1 2 3 4 5



TIMBER



Chancery Handle
White, Solid Wood
350mm - **2** KDH3037
800mm - **3** KDH3038



Chancery Handle
Dove Grey, Solid Wood
350mm - **2** KDH3033
800mm - **3** KDH3034



Chancery Handle
Cashmere, Solid Wood
350mm - **2** KDH3031
800mm - **3** KDH3032



Chancery Handle
Anthracite, Solid Wood
350mm - **2** KDH3035
800mm - **3** KDH3036



Spencer
Knob Handle
1 KDH3021

PRICE BANDS
1 2 3 4 5



Lighting

COLLECTION

Create the perfect mood with our carefully selected range of cabinet and plinth lighting. Our quality range of light solutions will not only make your space feel lighter and brighter, they add dimension and depth to create atmosphere and personality to any bedroom.

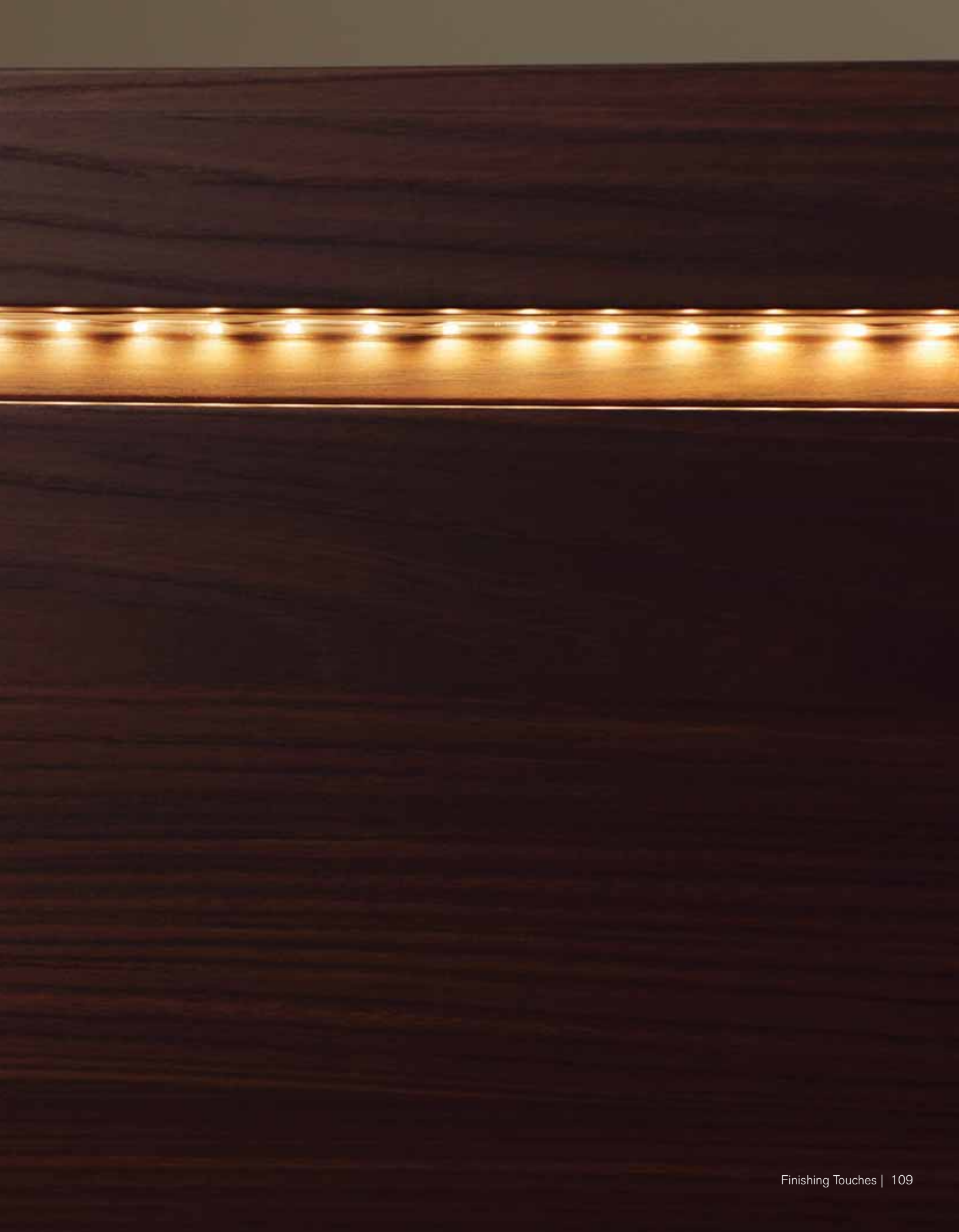

LIGHTING



SPOT LIGHTS

The LED chrome spot light creates subtle internal mood lighting when fitted due to the slim casing. These plug and play lights are simple to fit, whether you choose to surface mount the wiring or have them hidden into the shelves.

MAGNUM

Rechargeable Battery Light - no wiring required



Single
BSE3300N0
Wattage: 0.4W
Voltage: 3.7V
Qty: 1
LED Colour: Cool White

PINTO

LED Flat Disc Light



Pack
BSE10138WWK3.24
Wattage: 4.5
Voltage: 24V
Qty: 3
Driver: 6W Included
LED Colour: Warm White

Single
BSE10138WW.24
Wattage: 1.5
Voltage: 24V
Qty: 1
Driver: Required
LED Colour: Warm White



SLS QUADRA MODERN

LED Under/Over Cabinet Light



Single
BSE21092C0
Wattage: 2.5W
Voltage: 24V
Qty: 1
Driver: Required
LED Colour: Cool White

Single
BSE21092WW
Wattage: 2.5W
Voltage: 24V
Qty: 1
Driver: Required
LED Colour: Warm White



SENSORS

250W MOTION SENSOR SWITCH

This can be mounted inside a cabinet unit and will detect once the door is opened and will switch the light fitting on.

BSE40515
Wattage: 250W
Use with: 12V, 24V or 240V products
Cut-out: 20mm
Cable length: 1.5m
Detection range: 0.5m-2.5m



CABINET SENSOR SWITCH

Recess into the front of an interior shelf inside the cabinet. On opening the door the connected internal lights will switch on, when the door is closed the lights will switch off.

BSE40518
Wattage: 250W
Use with: 12V, 24V or 240V products
Cut-out: 13mm
Cable length: 2m
Detection range: 5-10cm





PLINTH LIGHTING

Integrate plinth lighting into your bedroom design to add dimension and depth. Our plinth lighting collection is stylish and discreet to create a stunning effect.

SPECTO LED Round Plinth Light



Pack
BSE15091C4
Wattage: 1.28W
Qty: 4
Driver: 6W Included
LED Colour: Cool White

Pack
BSE15091W4
Wattage: 1.28W
Qty: 4
Driver: 6W Included
LED Colour: Warm White

Pack
BSE15091C8
Wattage: 2.56W
Qty: 8
Driver: 6W Included
LED Colour: Cool White

Pack
BSE15091W8
Wattage: 2.56W
Qty: 8
Driver: 6W Included
LED Colour: Warm White

LUCE SLS LED Square Plinth Light



Pack
BSE15090W4
Wattage: 2.4W
Voltage: 24V
Qty: 4
Driver: 6W Included
LED Colour: Warm White

Pack
BSE15090W8
Wattage: 4.8W
Voltage: 24V
Qty: 8
Driver: 6W Included
LED Colour: Warm White



Pack
BSE15090C4
Wattage: 2.4W
Voltage: 24V
Qty: 4
Driver: 6W Included
LED Colour: Cool White

Pack
BSE15090C8
Wattage: 4.8W
Voltage: 24V
Qty: 8
Driver: 6W Included
LED Colour: Cool White



LED LIGHT

The LED lighting strip is our most versatile lighting option. This plug and play lighting can be used to backlight shelves, frame wardrobes or highlight dressing areas.



PRIMO

5M Clip LED Flexible Strip



Single
KDL4008
Wattage: 18W
Voltage: 24V
Qty: 1
Length: 5m
Driver: Required
LED Colour: Warm White

EVOLINE



BACKFLIP

The Evoline BackFlip sits nearly flush on a surface. At a touch of a finger, it turns 180 degrees to reveal two power sockets and a USB charger. With a total installation height of just 53mm, the BackFlip can be fitted above most drawers. Perfect to use on custom desks.



Black Glass (Gloss)
BBF2BK

Stainless Steel
BBF2SS

White Glass (Gloss)
BBF2WH



DECORATIVE LEGS

Beech Varnished Leg

BDL150BE

Size: 150mm
Qty: Pack of 4



Square stackable Feet

BSF80BC

Size: 180x80x60mm
Finish: bright chrome
Qty: Pack of 4



Decorative legs

BDL120CH

Size: 120mm, flat base
Finish: bright chrome
Qty: Pack of 4 with screws



Black mounted frame

BMODF430BK

Size: 1430x150mm



Chest

COLLECTION

Our beautiful range of modern and classic chests complement any bedroom style without compromising on space. These beautifully crafted pieces of furniture can integrate with the wardrobes, or stand alone.



Classic Chest: Two drawer bedside chest in Stone with Oak top
Handle: Leeming from the Nickel Collection (KDH3011)



Chest

CLASSIC COLLECTION



Classic Collection: 2 + 2 drawer in Oak effect
Handle: Yeadon from the Chrome Collection (KDH3017)

Chest

CLASSIC COLLECTION

To complement your fitted wardrobes, the classic chest collection offers a choice of six chests, from bedside to tall-boys and dressing tables to custom-fit desks. Whether you dream of colour-matched or contrasting tops, the classic chest can be individually styled through a choice of four colours, Partridge Grey, Porcelain, Stone and Oak.

Choose from unassembled or pre-assembled for the entire classic chest collection.



2 DRAWER
bedside

486mm width
x 576mm height
x 488mm depth



3 DRAWER
bedside

486mm width
x 754mm height
x 488mm depth



2 + 2 DRAWER

907mm width
x 754mm height
x 488mm depth



4 + 2 DRAWER

907mm width
x 1120mm height
x 488mm depth



TRADITIONAL
CUSTOM FIT DESK

2400mm width
x 754mm height
x 650mm depth



TRADITIONAL
DRESSING TABLE

1500mm width
x 754mm height
x 488mm depth

These chests are designed to fit seamlessly into any Chapter, Origin or Sliding bedroom. Please speak to a sales advisor to find out more.



2 +2 drawer chest in Porcelain with matching top. Spencer handle from the Timber Collection (KDH3021).



Classic dressing table in Stone with Oak top



Open drawer detail



Classic 3 drawer bedside chest in Partridge Grey with Matching top. Hampshire from the Pewter Collection (KDH3025).

TEXTURED WOODGRAIN EFFECT

Choose from matching or oak tops

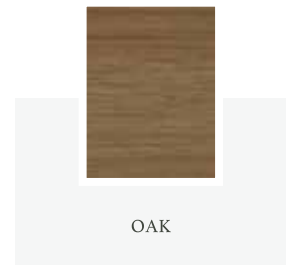
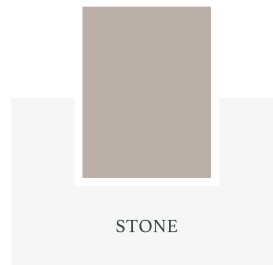
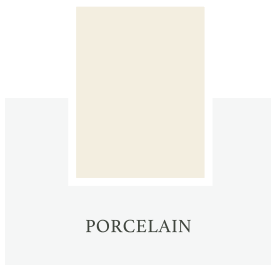



Chest

MODERN COLLECTION



Modern Chest: 4 drawer chest in gloss Cashmere
Handle: Crystal Bow handle from the Chrome Collection (KDH3008)

Chest

MODERN COLLECTION

Elegantly-styled proportions, paired with the delicate drawer detail, the modern collection offers a choice of two chests, creating a seamless modern look. The subtle proportions allow these pieces to stand alone, or fully integrate with the wardrobes. Available in Anthracite, Dove Grey, White and Cashmere, with a choice of gloss and matt drawer fronts.



500mm width
x 546mm height
x 482mm depth

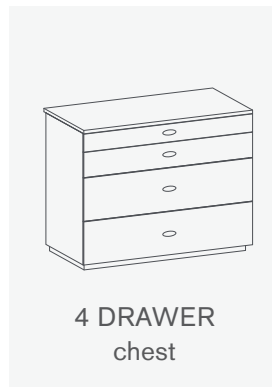

1000mm width
x 789mm height
x 482mm depth

These chests are designed to fit seamlessly into any Flow, Esker, Parity, Sculpt or Sliding bedroom.
Please speak to a sales advisor to find out more information.



Modern 3 drawer bedside in Gloss Cashmere. Crystal D handle from the Chrome Collection (KDH3009).



Open drawer detail. Sutton handle from the Chrome Collection (KDH3030)



Modern 4 drawer chest in Gloss White. Fimber handle from the Chrome Collection (KDH3029)



Modern 3 drawer bedside in Matt Anthracite. Yeadon handle from the Black Collection (KDH3015 - Backplate removed)

AVAILABLE IN

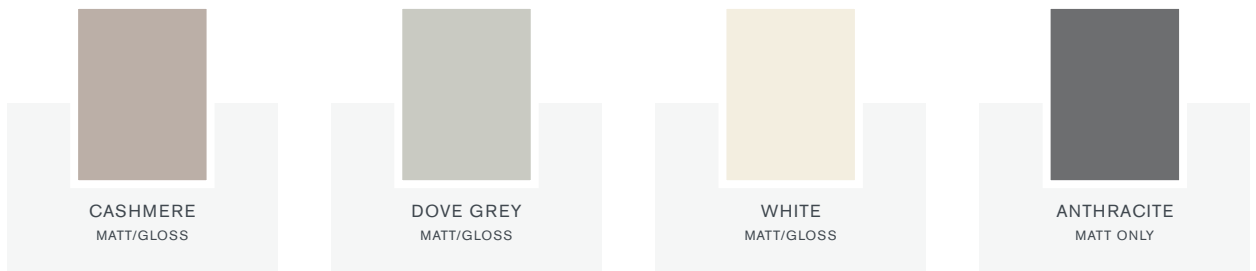

Cabinets are always matt. Drawer fronts only in Gloss



Bed

COLLECTION

Our classic bed frame has been carefully selected to work seamlessly with our classic ranges. Available in both double and king-size, with finishes of Porcelain, Stone and Partridge Grey. This bed frame is the perfect complement to complete your Origin, Chapter or Sliding Collection bedroom.



Oak accent on headboard



Side profile



Shaped leg detail

Available in



PORCELAIN

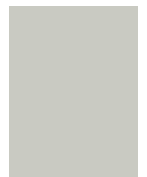

PARTRIDGE
GREY



STONE



ACCENT TOP
- OAK

*Double bed size - 1190 (H) x 1510 (W) x 2120mm (L)
*King bed size - 1190 (H) x 1660 (W) x 2190mm (L)

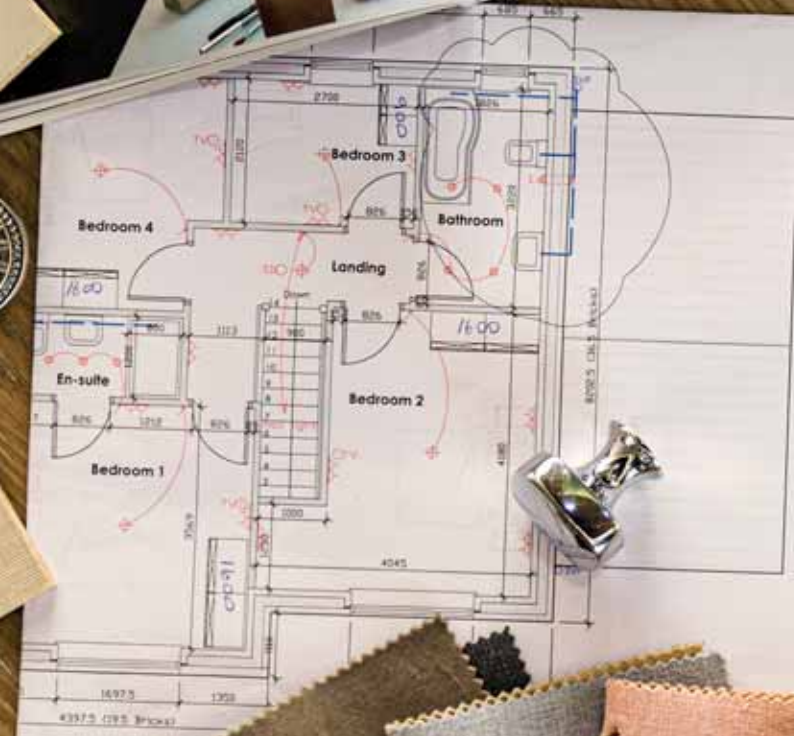

Same Plot
Bed 1 1600x610
Bed 2 1600x610
Bed 3 600x610
Bed 4 1600x610



Unit No. 4
Proposed Floor Plans and
Variations
5

Contract
Dulley Park
17/11/2022

Planning and Guidance

For advice on what to think about when planning and designing your dream bedroom take a look at the following pages.

Should you need any further advice, your sales advisor will be able to guide you on everything that's possible.

Hinged	128
Made-to-Measure	130
Sliding	132

HINGED

HOW TO PLAN FOR YOUR HINGED WARDROBES

Step 1. Measure your space

Ensure you are fully equipped to start planning. Measure your space wall to wall, including ceiling heights. Remember to note down things like:

- ✓ Sockets
- ✓ Switches
- ✓ Window ledges
- ✓ Radiators
- ✓ Doors



Step 2. Create a wardrobe run

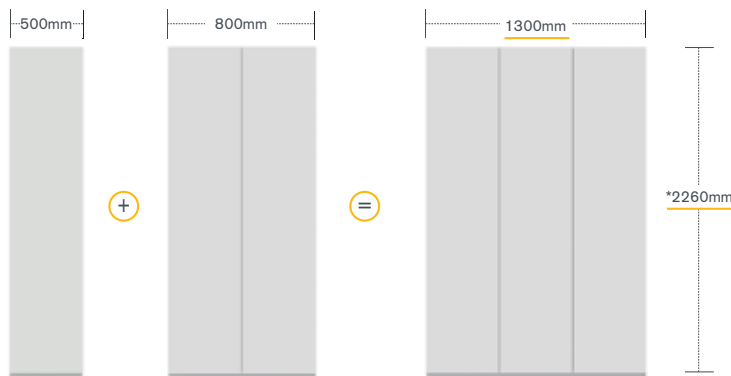

Get an idea of the wardrobe you want by adding combinations together.

Step 3. Add end panels/fillers or posts

Depending on whether your design is wall to wall or open ended, you will need to add either an end panel or a custom fit plinth as a filler to cover the linen coloured cabinet.

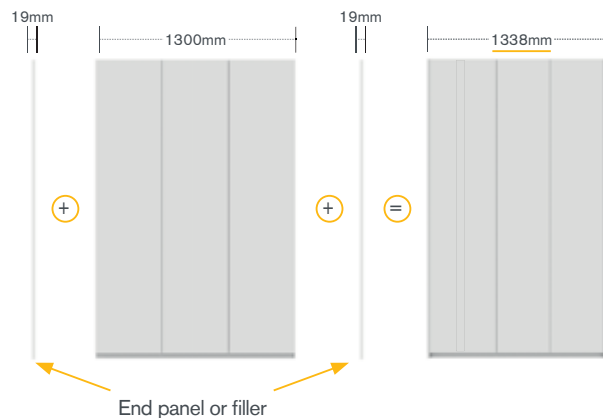

Step 4. Add cornice and plinth

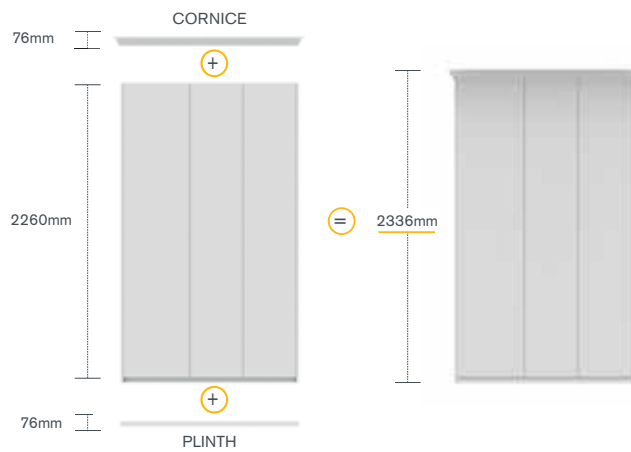

You will always need to use a length of plinth to cover the structural base of the wardrobe and depending on whether your design has the space, you can either add a cornice or an infill to ceiling, to finish off the wardrobe.

Step 5. Add your internals

We have multiple internal storage options for our wardrobes. You can choose from pre-determined bundles or create and design your own, depending on your storage needs.

For the full internals section please see page 42.



MADE-TO-MEASURE

HOW TO PLAN FOR YOUR HINGED WARDROBES

Step 1. Measure your space

Ensure you are fully equipped to start planning. Measure your space wall to wall, including ceiling heights. Remember to note down things like:

- ✓ Sockets
- ✓ Switches
- ✓ Window ledges
- ✓ Radiators
- ✓ Doors

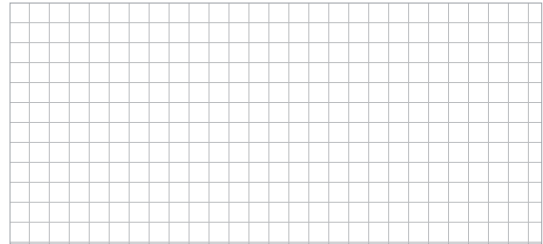

Step 2. How many doors

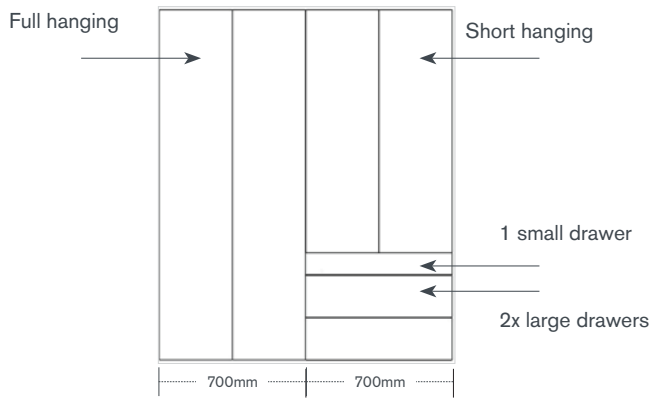

Using the measurements get an idea of the wardrobe storage you want by drawing out how many drawers and doors you require.

Step 3. Add end panels/fillers or posts.

Decide if you want to include end panels, fillers or posts on your wardrobes or have a decorative cabinet

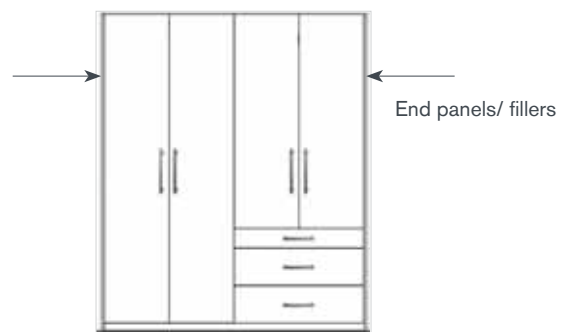
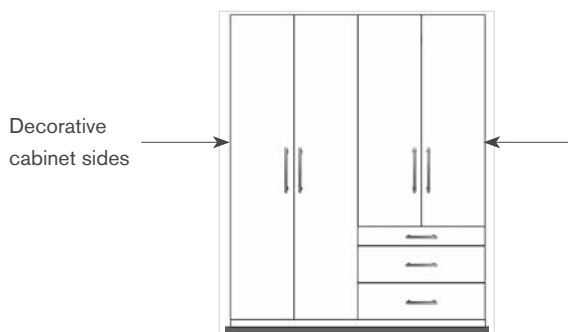

Step 4. Height

Decide what height you want your storage to be

Wardrobes right to the ceiling



Wardrobes with space above



Step 5. Add your internals

Depending on your storage needs, design your own internals.



MADE-TO-MEASURE / SLIDING

HOW TO PLAN FOR YOUR SLIDING WARDROBES

Step 1. Measure your space

Ensure you are fully equipped to start planning. Measure your space wall to wall, including ceiling heights. Remember to note down things like:

- ✓ Sockets
- ✓ Switches
- ✓ Window ledges
- ✓ Radiators
- ✓ Doors



Step 2. Create a wardrobe run

You will need to decide how many doors you would like for your run. Whether its 2, 3 or 4.

Please bear in mind if you are using internal storage how this would work with the number of doors you require.

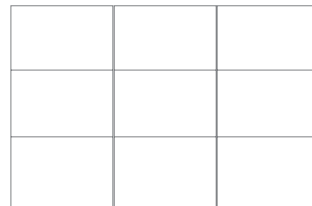

Step 3. Choose your Aluminium frame profile

Depending on the look you are aiming to achieve with your sliding wardrobe will depend on the frame you may choose. We have 5 frame types and 6 frame colours to choose from; some may be easier for you to open than others as each frame type has a different shape.

Its best that you take the time to select the frame that is best for you, as once selected it cannot be changed.

FRAME OPTIONS



PRISM



FIGURE



CURVE



CUBE



SHAPE

FRAME PROFILE COLOUR



SATIN SILVER



WHITE GLOSS



BLACK GLOSS



CHAMPAGNE



WENGE WOODGRAIN



WENGE HIGH GLOSS

Step 4. Choose your door styles



FULL PANEL



EQUAL TWO



LOW 400



CENTRAL 400



EQUAL THREE



WIDE 400



WIDE 300

Step 5. Choose your door finishes

Choose from over 35 colours across matt and gloss coloured board, woodgrain board, glass, satin glass and mirror.

Whether you would like all one colour or mix of materials, the choice is yours.

WOODGRAIN BOARD COLOURS



CLASSIC PORCELAIN

CLASSIC GREY

CLASSIC STONE

OAK

WALNUT

BOARD COLOURS

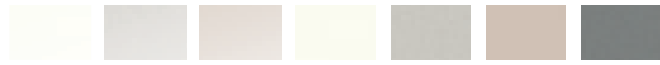

GLOSS WHITE

GLOSS DOVE GREY

GLOSS CASHMERE

MATT WHITE

MATT DOVE GREY

MATT CASHMERE

MATT ANTHRACITE

GLASS COLOURS



WHITE

RICH ALUMINIUM

CLASSIC GREY

CASHMERE

DAKAR

STONE GREY

METAL TAUPE

BLUE SHADOW

ANTHRACITE

AUBERGINE

STARLIGHT BLACK

SATIN GLASS COLOURS



SATIN WHITE

SATIN SILVER

SATIN GREY

SATIN CASHMERE

SATIN DAKAR

SATIN STONE GREY

SATIN BRONZE

SATIN ANTHRACITE

SATIN BLACK

MIRROR



SILVER MIRROR

BRONZE MIRROR

GREY MIRROR

Step 6. Choose your end panel and liners

Choose from 14 colours across matt and gloss coloured board, woodgrain and textured board.

See page 86 for all colour options.



End panel



Liner

Step 7. Choose your internals

Choose from 11 colours across matt coloured, woodgrain and textured board.

See page 86 for all colour options.



Shelf and hanging rail

THE
Bedroom
COLLECTION

We take great care in the photography of the product featured. However, there may be slight variables between photographic and print processes, colours may vary slightly from the actual product supplied.



THE
Bedroom
COLLECTION

Spring 2020 - PWS Distributors Ltd